

August 18, 2023

## GENERAL LETTER NO. 14-O-8

ISSUED BY: Bureau of Financial, Food, and Work Supports  
Division of Community Access

SUBJECT: Employees' Manual, Title 14, Chapter O, **PJCase System**, Title Page, Contents 1 and 2, I-114, revised; I15-153, removed.

### Summary

This chapter is revised to remove references to now obsolete JOBS coding in the ABC system, remove references to BRS, and update language to align with the reorganization of the Department of Health and Human Services from the Department of Human Services, and to update style and formatting throughout.

### Effective Date

June 5, 2023.

### Material Superseded

Remove the following pages from Employees' Manual, Title 14, Chapter O, and destroy them:

<u>Page</u>	<u>Date</u>
Title Page	March 18, 2022
Contents 1 and 2	March 18, 2022
I-153	March 18, 2022

### Additional Information

Refer questions about this general letter to your area income maintenance administrator.

STATE OF IOWA DEPARTMENT OF

**Health** AND **Human**

SERVICES

Employees' Manual  
Title 14, Chapter 0

Revised August 18, 2023

# PJCase System

	<u>Page</u>
<b>Overview .....</b>	<b>I</b>
<b>Functions Used by Both IM and PJ Staff.....</b>	<b>2</b>
Accessing the System for the First Time .....	2
Changing Your Password.....	4
Changing Your Email User ID.....	6
Logging In.....	7
PJCase Main Menu .....	9
Search.....	10
Navigation and Field Formatting .....	12
Changing or Canceling an Entry .....	12
Changing or Canceling an LBP Entry.....	13
Refreshing an Entry.....	13
PJCase Person Screen.....	16
Accessing the PJCase Person Screen.....	17
LBP Display Screen.....	23
Accessing the LBP Display Screen.....	23
Stopping an LBP.....	27
LBP - Stop Screen.....	27
Steps to Stop an LBP .....	32
Completing Stop LBP Function From the LBP - Stop Screen .....	35
Result of Stopping an LBP .....	36
Stopping One LBP for a Household with Multiple LBPs.....	37
PJ Expense Screens .....	40
Viewing PJ Expenses .....	45
Self-Employment Income Screen.....	46
Viewing Self-Employment Income.....	47
<b>Income Maintenance Functions .....</b>	<b>48</b>
Adding a Person to an LBP.....	48
Changing an LBP Stop Reason .....	51
Correcting an LBP Type.....	53
Reactivating an LBP.....	55
Reactivating LBP Stopped for Reason A.....	55
Reactivating LBP Stopped for Reason Other Than A.....	59
Reassigning an LBP to a New Case Number .....	61
Results of Reassigning an LBP to a New Case Number .....	64
<b>PROMISE JOBS Functions.....</b>	<b>64</b>
Assigning PJCase Person to PJ Caseworker .....	64
Changing an Active FIA Date.....	65
Pre-FIP Entries: Applicant Did Not Choose LBP.....	66
FIA Signed.....	69
FIA Not Signed.....	71
Pre-FIP Entries: Applicant Chose LBP.....	72
Issuing Expense Allowance Payments .....	73
Issuing Payment to a Participant.....	77
Issuing Payment Directly to a Provider .....	79

---

	<u>Page</u>
Payment Pended for PJ QA Review.....	82
Changing or Canceling an Expense Allowance Entry.....	83
Viewing Expenses Entered and Not Yet Processed.....	83
Reactivating an LBP.....	84
Starting an LBP.....	84
LBP Start Key Entry Screen.....	85
LBP - Start Screen.....	87
Steps to Start an LBP.....	89
Results of Starting an LBP.....	92
When More Than One Household Member Chooses an LBP.....	93
Child Care Invoice Return Screen.....	95
<b>Calendar Functions.....</b>	<b>95</b>
Accessing Calendar.....	95
PJCase Calendar Menu.....	95
Manage Time Slots Option.....	96
Adding Time Slots.....	98
Other Notes for Adding Time Slots.....	101
Deleting Time Slots.....	101
Schedule Appointments Option.....	104
PJCase Calendar Available Days Screen.....	105
PJCase Calendar Day Screen.....	106
Scheduling Appointments When More Than Person Is Referred.....	107
Steps to Schedule an Appointment.....	107
Other Notes When Scheduling an Appointment.....	110
View a Day Option.....	110
PJCase Calendar View A Day.....	111
View/Update Client Option.....	112
PJCase Calendar Appointment Screen.....	113
Delete an Appointment.....	114
Update the Comment Fields.....	114
Reschedule an Appointment.....	114

---

## **Overview**

The PJCase system is an online data management system that interacts with the Department of Health and Human Services' (HHS or The Department) Automated Benefit Calculation (ABC) system and the JOBS referral and expense systems.

PJCase maintains a database of case information on current and former Family Investment Program (FIP) participants who have been referred to PROMISE JOBS for work and training services. The database information comes directly from the ABC system and the JOBS referral system.

The PJCase system uses information from the database and from other systems to edit and to make decisions when processing entries made by HHS income maintenance (IM) staff and by PROMISE JOBS (PJ) staff in the Iowa Workforce Development Department (IWD).

When processing an entry, PJCase takes some actions in “real time.” This means that the result of the entry is immediately reflected in PJCase, ABC, or the JOBS referral system if the entry is accepted. Likewise, PJCase displays an online error message when edits find the entry is not complete or not appropriate. This gives the worker an opportunity to correct the entry and continue, or to cancel the entry.

Some entries in PJCase may generate a transaction to force ABC to recalculate benefits or to send a notice of decision. Such a transaction would be processed at night in a separate run.

To complete the referral process, the JOBS referral system considers updated entries made in ABC and in PJCase to determine if IWD needs to be notified.

As a result, HHS sends IWD a file of records that will be processed into PROMISE JOBS' PJOB system. The file includes records of people who are new PJ referrals, people who were previously referred to PJ and whose FIP is now canceled or denied, and of other changes made on an actively referred person's case, such as an address change.

HHS staff who oversee the FaDSS program have “read-only” access to PJCase. This allows them to view display screens such as PJCASE PERSON screen and history and LBP information, including history and calendar appointments.

PJ and IM workers use PJCase to perform the following functions:

- Only IM workers have the ability to:
  - Reassign an LBP to another case.
  - Reactivate an LBP.
  - Add people to an LBP.
  - Change the stop reason for an LBP.
  - Correct the type of an LBP.

- Only PJ workers have the ability to:
  - Issue expense allowance payments to FIP participants.
  - Start LBP on FIP participants who fail to sign an FIA, or who sign an FIA and fail to follow the steps.
  - Record that a FIP applicant signed an FIA, failed to sign an FIA, or abandoned reconsideration of an LBP.
  - Allocate FIA appointment time slots for IM to use when scheduling FIP applicants who must sign an FIA.
- Both IM and PJ workers have the ability to:
  - View active and inactive LBP information for specific cases and people.
  - Stop an LBP.
  - View, schedule, or cancel an applicant's FIA appointment.
  - View a list of FIA appointments scheduled for a particular PJ office on a specific day.
  - View PJ expenses history for FIP participants.

This chapter contains separate sections for each of the PJCase functions.

### **Functions Used by Both IM and PJ Staff**

This section contains information that both income maintenance and PJ workers need to know in order to use the PJCase system effectively.

#### **Accessing the System for the First Time**

IM staff who are authorized to update in the ABC system are also authorized to use the PJCase system. To get PJCase access and ABC update authorization for IM staff, the IM supervisor completes *Electronic Security Information*, form 470-2078, and selects "ABC Update" in the CICST001 field on page 2.

To get PJCase authorization for an HHS employee who has view-only access to ABC, the supervisor completes form 470-2078, writing "PJCase" in the "Check Requests" section and selects "IABC View" in the CICST001 field on page 2.

To get PJCase authorization for PROMISE JOBS staff, the PJ supervisor completes and sends IWD's electronic *Access Request* for the employee. An IWD PROMISE JOBS coordinator completes and returns the *Access Request* to the PJ supervisor once the employee's access has been authorized or denied.

To log in to PJCase for the first time, follow these steps:

Step	Action
1	<p>Access the PJCase system by clicking on the link provided by the HHS Division of Data Management.</p> <ul style="list-style-type: none"> <li>▪ For IM workers, a link is located on the Field IM Staff SharePoint site.</li> <li>▪ For PROMISE JOBS workers, a link is located on the PROMISE JOBS SharePoint site.</li> </ul>
2	<div data-bbox="378 579 1170 1056" data-label="Image"> </div> <p>On the Welcome-PJCase Login screen, complete entries in the following fields:</p> <ul style="list-style-type: none"> <li>▪ <b>AGENCY:</b> Enter the agency code that applies to you:             <ol style="list-style-type: none"> <li>1 IWD PROMISE JOBS (includes agencies who subcontract with IWD to provide PROMISE JOBS services)</li> <li>4 IM worker</li> <li>6 HHS FaDSS staff</li> </ol> </li> <li>▪ <b>COUNTY ID:</b> Enter the two-digit code that corresponds to the county where your agency office is located.</li> <li>▪ <b>WORKER ID:</b> Enter your three- or four-digit worker identification number.             <p><b>For IM staff, this is the same worker number that you use in the ABC system.</b></p> <p><b>For PROMISE JOBS staff, this is the same assigned STDK identification number that you use in IWD’s PJOB system.</b></p> <p><b>For HHS FaDSS staff, this is the user identification you selected when added to the system.</b></p> </li> <li>▪ <b>PASSWORD:</b> Enter the default password provided to you when you received confirmation of your authorization to use PJCase.</li> </ul>

Step	Action
3	Click the SUBMIT LOGIN button.  Upon validating your entries, PJCase will display the Change Password screen. (See <a href="#">Changing Your Password</a> .)
4	On the CHANGE PASSWORD screen, you must change your password from the default password to one you create. (See <a href="#">Changing Your Password</a> .)
5	After changing your password for the first time, the system will display the EMAIL USER ID screen. You must associate your email address with the PJCase system. (See <a href="#">Changing Your Email User ID</a> .)

NOTE: PJCase contains a password and email address for each county ID/worker ID combination. If you work in more than one county, you will have PJCase authorization under **each** county ID/worker ID combination.

When logging in for the first time, follow the steps for **each** applicable county ID/worker ID combination. When you log in for the first time, you attach your password and email address to the entered worker ID/county ID combination only. If you have cases or people in your worker ID with another county ID, you will not receive any PJCase generated emails on these cases or people.

### **Changing Your Password**

To change your PJCase password, follow the step action chart below:

NOTE: As a first-time user, you are automatically taken to the Change Password screen when you login whether or not you click on the box by Check to Change Your Password on the Welcome-PJCase Login screen. Begin with Step 3 to change your password after you are at the Change Password screen.



Step	Action
1	Access PJCase.
2	On the Welcome-PJCase Login screen, complete entries in the AGENCY, COUNTY ID, WORKER ID, and PASSWORD fields and click the box in front of Check to Change Your Password. The system will enter a check mark in the box. Press SUBMIT LOGIN.



Step	Action
3	<p>The system will display the Change Password screen.</p>  <p>Type your new password in the ENTER YOUR NEW PASSWORD field. The password must meet the following criteria:</p> <ul style="list-style-type: none"> <li>▪ Be at least six characters,</li> <li>▪ Contain no more than eight characters, and</li> <li>▪ Include only letter characters A through Z or numbers 0 through 9</li> </ul>
4	<p>Re-type your password in the field, RE-ENTER YOUR NEW PASSWORD.</p>
5	<p>Click on “SUBMIT NEW PASSWORD.”</p> <ul style="list-style-type: none"> <li>▪ If the change is successful, the system will display the Change Password Confirmation screen.</li> <li>▪ If the change is not successful, the system will display an error message in red text. Repeat steps 3 and 4 making appropriate changes.</li> </ul> <p>NOTE: Click on CANCEL at any time to stop your entries and return to the Welcome-PJCase Login screen</p>

## Changing Your Email User ID

To change your email user identification, follow these steps:

Step	Action
1	Access PJCase.
2	<p>On the Welcome-PJCase Login screen, complete entries in the AGENCY, COUNTY ID, WORKER ID, PASSWORD fields and click the box in front of Check to Change email Address. The system will enter a check mark in the box.</p>  <p>Press SUBMIT LOGIN.</p>
3	<p>On the Email User ID screen, enter the portion of your email address that proceeds the “@” symbol in the EMAIL USER ID: field.</p> 
4	<p>Select either:</p> <ul style="list-style-type: none"> <li>▪ Change EMAIL USER ID to update the system with your email user ID, or</li> <li>▪ Cancel to stop processing the change and return to the Welcome-PJCase Login screen.</li> </ul>
5	<p>If your entry is successful, the system will display the Change email User ID Confirmation screen.</p> 

Step	Action
	Select either: <ul style="list-style-type: none"> <li>▪ CHANGE EMAIL USER ID to confirm change and continue to the PJCASE MAIN MENU, or</li> <li>▪ CANCEL to stop your entry and return to the Change email User ID screen.</li> </ul> If your entry is not successful, you will receive an error message in red text. Repeat steps 3 and 4 making appropriate changes.
6	To leave the Change email User ID Confirmation screen, either: <ul style="list-style-type: none"> <li>▪ Select CANCEL to return to the PJCase Main Menu, or</li> <li>▪ Exit the program.</li> </ul>

### Logging In

NOTE: You must be authorized by HHS Quality Assurance to access the PJCase system.

The system will display the WELCOME-PJCASE LOGIN screen.

The screenshot shows a login interface with the following elements:

- Title:** Welcome - PJCase Login
- Logo:** Promise Jobs. Promoting Independence and Self-Sufficiency through employment. Job Opportunities and Basic Skills. The Department of Human Services in Partnership with the Departments of Economic Development, Education, Human Rights, Management, and Workforce Development.
- Input Fields:**
  - Enter Your Agency: [ ]
  - Enter Your County ID: [ ]
  - Enter Your Worker ID: [ ]
  - Enter Your Password: [ ]
- Checkboxes:**
  - Check to Change Your Password
  - Check to Change E-mail Address
- Button:** Submit Login

To log in, follow these steps:

Step	Action
1	<p>Complete entries in the following fields:</p> <ul style="list-style-type: none"> <li>▪ <b>AGENCY:</b> Enter the agency code that applies to you:               <ul style="list-style-type: none"> <li>1 IWD PJ staff (includes agencies who subcontract with IWD to provide PJ services)</li> <li>4 HHS IM worker</li> <li>6 Legacy DHR staff</li> </ul> </li> <li>▪ <b>COUNTY ID:</b> Enter the two-digit code that corresponds to the county where your agency office is located.</li> <li>▪ <b>WORKER ID:</b> Enter your three-digit or four-digit worker identification number.               <p><b>IM staff:</b> Use the worker number that you use in the ABC system.</p> <p><b>PJ staff:</b> Use the assigned STDK identification number that you use in the PJOB system.</p> <p><b>Legacy DHR staff:</b> Use the user identification you selected when you were added to the PJCase system.</p> </li> <li>▪ <b>PASSWORD:</b> Enter your password. (When you are logging in for the first time, see <a href="#">Accessing the System for the First Time.</a>)</li> </ul>
2	Click the SUBMIT LOGIN button.
3	<p>PJCase will edit your entries and one of the following will happen:</p> <ul style="list-style-type: none"> <li>▪ If the system validates your login entries, and your password is less than 60 days old, PJCase will display the PJCase Main Menu screen.</li> <li>▪ If the system validates your login entries, and your password is 60 days old or longer, PJCase will display the CHANGE PASSWORD screen. (See <a href="#">Changing Your Password.</a>)</li> <li>▪ If any entry is not valid, you will receive an error message in red text to explain, and you will remain in the Welcome-PJCase Login screen until you correct your entry or exit PJCase.</li> </ul>

NOTE: For security purposes, if you are inactive in PJCase for more than 20 minutes, you will be logged out by the system and will need to log in again.

## PJCase Main Menu

The system displays the PJCase Main Menu screen after accepting your login entry. Use the main menu to access Calendar Menu, LBP Activity Menu, or to search for LBP or referral information and expense history.

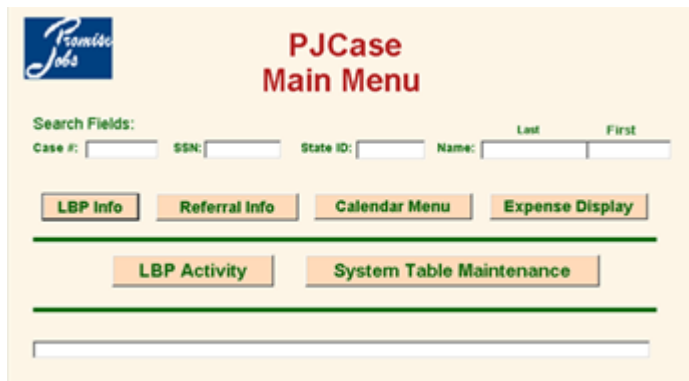

The following fields and buttons are located on the PJCase Main Menu screen:

- **CASE #:** Used to enter the first nine digits of the ABC case number with no hyphens.
  - **SSN:** Used to enter the nine-digit social security number with no hyphens.
  - **STATE ID:** Used to enter the client's state identification number. The entry must contain eight characters and end with a letter.
  - **NAME:** Used to enter the client's last and first name.
  - **LBP INFO:** This is a search button. See [Search](#) for more information.
  - **REFERRAL INFO:** This is a search button. See [Search](#) for more information.
  - **CALENDAR MENU:** Use this option to view the PJCase Calendar menu. See [PJCase Calendar Menu](#) for screen display. Workers use PJCase Calendar to:
    - Manage time slots
    - Schedule appointments
    - View a day
    - View/update client
- See [PJCase Calendar Menu](#) for more information.
- **EXPENSE DISPLAY:** Available to IM and PJ staff. This is a search button. See [Search](#) for more information.

- **LBP ACTIVITY:** This option is only available to IM staff. Use this option to access the LBP ACTIVITY MENU and each of the IM functions. This option allows IM workers to:
  - Reassign LBPs,
  - Stop LBPs,
  - Reactivate LBPs,
  - Add a person to an LBP, or
  - Make other LBP changes.See [Income Maintenance Functions](#) for more information.
- **SYSTEM TABLE MAINTENANCE:** This option is not currently available for use by either IM or PROMISE JOBS staff.

## Search

The PJCase system allows you to search for LBP or referral information and PJ expense histories by using case numbers, social security numbers, state identification numbers, and the client's first and last name. Searches are performed on the PJCase Main Menu screen.

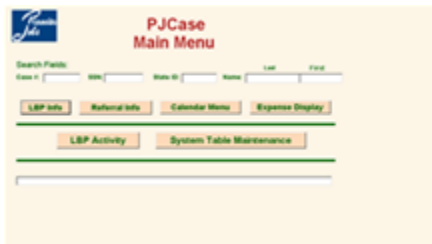

Use one of the following search fields on the PJCase Main Menu to define your search.

- **CASE #:** Enter the first nine digits of the ABC case number with no hyphens.
- **SSN:** Enter the nine-digit social security number with no hyphens.
- **STATE ID:** Enter the client's state identification number. The entry must contain eight characters and end with a letter.
- **NAME:** Entry of at least the last name is mandatory for a name search. If known, enter the first name or as many letters that you are sure about. The system will return all matching names that meet the criteria you enter.

For example, if you want to search for a person named Mindi Martin, but you are not sure if the last letter of her first name is an "i" or a "y," enter her first name as Mind. The system will display all people whose last name is Martin and whose first name **begins** with Mind.

After entering the search criteria, select one of the following search options:

- **LBP INFO:** Use this option to view LBP information regarding a case or person, or to make an entry on an active LBP. A search using this option will cause the system to display the LBP LIST screen, which contains all active or inactive LBPs that matched your search criteria.

A search by case number and LBP INFO will display the LBP List screen with all active and inactive LBPs assigned to the case number. If a person on the case chose an LBP while receiving FIP on another case number, the LBP on the other case will not display with a case number search unless the IM worker has reassigned the LBP to the current case number. (See [Reassigning an LBP to a New Case Number](#) for more information.)

A search by social security number or state identification number and LBP INFO will display the LBP List screen with all the active and inactive LBPs that the person has been associated with.

From the LBP LIST screen, select the LBP you want to view by entering any character in the DISPLAY? Column next to the LBP and click on the DISPLAY LBP button.

- **REFERRAL INFO:** Use this option when you need to:
  - View information about people referred to PJ.
  - Perform the following functions:
    - Issue Pjexpense allowances. (PJ staff only.)
    - View information regarding the dependents on the referred person's case.
    - View LBP information after viewing information about the referred people.
    - Start an LBP. (PROMISE JOBS staff only.)
    - Stop an LBP.
  - View the history of referral transactions for a person.

A search using the REFERRAL INFO button results in the PJCase Person List screen being displayed. If you search by case number, the list will include all people on the ABC case who are currently and formerly referred to PJ. If you search by social security number or state identification number, the list will display only that person.

Select the person whose referral you want to view by entering any character in the box in the DISPLAY? Column next to the person. Click on the REFERRAL INFO box to display the PJCase Person screen.

NOTE: If there is more than one person on the list, click in the DISPLAY? Column box of the desired person and the system will populate the field with an "X."

- **EXPENSE DISPLAY:** Available to IM and PROMISE JOBS staff. Use this function to view PJ expenses either by ABC case number, person's SSN or State ID. See [PJ Expense Screens](#) for more information.

## **Navigation and Field Formatting**

To move from field to field within a screen, you can either use your TAB key or click in the desired field using your mouse.

To return to a previous screen, click on the BACK button in the upper left corner of the browser window. NOTE: When you use the BACK button, any actions you took on previous screens will not be reflected on those screens when you return to them. Example:

Worker A has stopped an LBP for Client B. When Worker A clicks the BACK button to return to the LBP Display screen, the LBP does not appear to be stopped. To see the updated change on LBP Display screen, the worker must return to the PJCase Main Menu screen and re-access Client B's LBP information.

To exit the program:

- Click on the "X" in the upper right corner of the screen, or
- Select the FILE option in the upper left corner of your browser and select CLOSE.

**Do not** click on STOP to exit the program.

PJCase contains several fields with specific requirements with respect to how many characters can be entered and the format of the entries.

- **DATE FIELDS:** Enter in MM-DD-CCYY format. The date must include dashes and the year must have four digits. PJCase will not accept slashes in date fields.
- **IABC CASE ID #:** Enter the first nine digits of the ABC case number with no dashes. The system does not require entry of the tenth digit.
- **SOCIAL SECURITY NUMBER:** Enter the nine digits with no hyphens.
- **STATE ID:** The number must contain eight characters and end with a letter.

## **Changing or Canceling an Entry**

If you are still on the screen in which you made entries, make any necessary changes before clicking on the button that submits the entries. Clicking on CANCEL at any time before you submit your entries will erase your entries and return you to the PJCase Main Menu or the LBP Activity Menu.

Once you have clicked on a button to submit your entries, a confirmation page will display. You have the opportunity to either confirm your entries or click CANCEL to return to the PJCase Main Menu or the LBP Activity Menu.



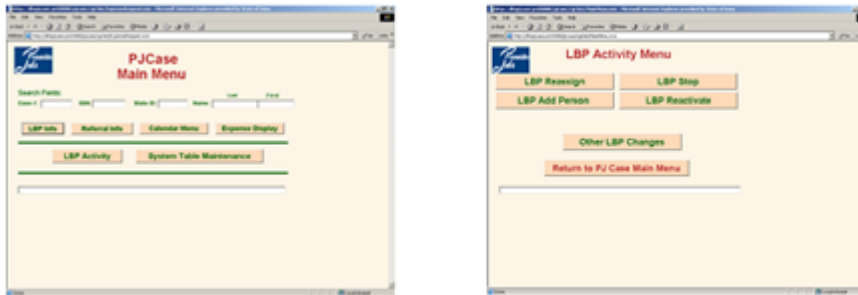

### **Changing or Canceling an LBP Entry**

If you have confirmed any LBP entry (LBP Start, LBP Stop, LBP Reassign), you may change or delete the entry **on the same day** that you made the entry, after you refresh the entry. See [Refreshing an Entry](#).

### **Refreshing an Entry**

Since PJCase processes and updates these transactions in real time, a refresh function is needed to allow IM and PJ staff to correct an entry made on the same day.

The refresh function applies to LBP transactions made in the Pre-FIP section of the FIA Menu in PJCase. The refresh function does not apply to PJ expense allowances and the function does not interfere with any ABC transactions made by IM in the same day.

When entry is made to refresh an LBP transaction from an LBP Display screen, the refresh function erases all transactions made on any LBP on the case.

When entry is made to refresh a Pre-FIP entry from a person's FIA Menu screen, the refresh function erases only the FIA entries made on that person.

Refreshing an entry resets the individual information in the systems (PJCase and ABC) to the way that they existed after the previous ABC nightly batch processing. It also generates an email to the opposite worker (i.e., if PROMISE JOBS refreshes transactions, the IM worker gets an email and vice versa) except when the worker of record is the worker making the refresh entry.

The email is needed to alert the other worker because:

- The other worker may also have made transactions in PJCase that would be affected by the refresh, or
- The IM worker may have made entries in ABC that may be affected by the refresh. Even though the refresh function does not affect IM transactions in ABC, the IM worker may have made the ABC transaction after "real time" updates from the refreshed transactions.



When ABC generates a *Notice of Decision (NOD)* and benefits as a result of IM's entry, this may conflict with the refreshed FIP and LBP status. The IM worker may need to take additional actions in ABC as the result of the PJCase refresh entry.

In the morning, a PJ worker makes entries to stop an LBP due to reason code “R.” PJCase deactivates the LBP, changes the FIP status code to “N,” and sends the IM worker an email. The IM worker makes entries in ABC to approve the pending FIP application.



In the afternoon, the PJ worker realizes the stop entry was incorrect and uses the refresh function. Processing of the refresh entry reactivates the LBP, changes the FIP status code back to “I,” and sends an email to the IM worker. Since ABC processes in real time, ABC will generate an NOD and FIP benefits based on IM’s approval entry even though the LBP is active again.



The IM worker must make an entry in ABC to generate an NOD that says FIP is canceled due to the LBP. FIP issued as a result of the approval is subject to recoupment.

To refresh an LBP entry made on the current day, follow these steps:

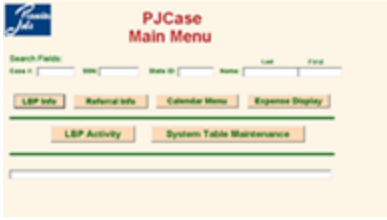
Step	Action
1	<p>On the PJCase Main Menu, enter the person’s case number, SSN, state ID number, or name in the appropriate search field and click on LBP info.</p> <ul style="list-style-type: none"> <li>▪ If there is more than one LBP, the system displays the LBP List screen. Go to Step 2.</li> <li>▪ If there is only one LBP, the system displays the LBP Display screen. Go to Step 3.</li> </ul>
2	 <p>On the LBP List screen, enter an “X” in the DISPLAY? column next to the applicable LBP and select DISPLAY LBP. The system displays the LBP Display screen.</p>
3	 <p>Select REFRESH LBP to display the LBP Refresh Confirmation screen.</p>
4	<p>Select either:</p> <ul style="list-style-type: none"> <li>▪ REFRESH LBP, to confirm your entry, or</li> <li>▪ CANCEL, to stop the system from “refreshing” the entries you made earlier in the day.</li> </ul>

To refresh a Pre-FIP entry made on the current day, follow these steps:

Step	Action
1	 <p>On the PJCase Main Menu screen, enter the person’s case number, social security number, state identification number, or name in the applicable SEARCH field. Select REFERRAL INFO.</p> <p>If there is more than one referred person on the case, the PJCase Person List screen will be displayed. Go to Step 2.</p> <p>If there is only one referred person on the case, the PJCase Person screen will be displayed. Go to Step 3.</p>
2	 <p>On the PJCase Person List screen, enter an “X” in the DISPLAY? column next to the name of the person who chose the LBP. Select DISPLAY REFERRAL. The system displays the PJCase Person screen.</p>
3	 <p>Select either:</p> <ul style="list-style-type: none"> <li>▪ FIA MENU, to access the FIA Menu (go to Step 4), or</li> <li>▪ return to pjcase main menu, to cancel your entry.</li> </ul>

Step	Action
4	 <p>Select either:</p> <ul style="list-style-type: none"> <li>REFRESH REFERRAL, to display the Refresh PJCase Person Confirm screen, or</li> <li>RETURN TO PJCASE PERSON, to stop the system from refreshing the FIA entries you made earlier in the day.</li> </ul>
5	 <p>On the Refresh PJCase Person Confirm screen, select either:</p> <ul style="list-style-type: none"> <li>COMPLETE REFRESH to confirm your entry, or</li> <li>CANCEL to stop the system from “refreshing” the FIA entries you made earlier in the day.</li> </ul>

**PJCase Person Screen**

The PJCase Person screen displays specific information regarding a person who is currently or formerly referred to PJ. The screen also displays information regarding the PJ worker and the IM worker associated with the case and gives access to certain functions.



Both IM and PJ staff use this screen to:

- View information regarding a referred person.
- Stop an LBP.
- Access LBP information.
- Access a history of referral changes.
- Access a list of other people associated with the referred person’s case (other parents and children).

PJ staff use this screen to access the LBP Start, Expenses and Pre-FIP functions.

**Accessing the PJCase Person Screen**

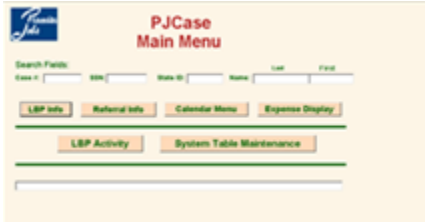
To access the PJCase Person screen, follow these steps:

Step	Action
1	 <p>On the PJCase Main Menu screen, enter the person’s case number, social security number, state identification number, or name in the applicable SEARCH field. Select REFERRAL INFO.</p> <p>If there is more than one referred person on the case, the PJCase Person List screen will be displayed. Go to Step 2.</p> <p>If there is only one referred person on the case, the PJCase Person screen will be displayed.</p>
2	 <p>On the PJCase Person List screen, enter an “X” in the DISPLAY? column next to the name of the person who chose the LBP. Select DISPLAY REFERRAL. The system displays the PJCase Person screen.</p> 

The PJCase Person screen contains the following fields:

- **STATE ID:** Displays the referred person’s state identification number (SID.)
- **CASE ID:** Displays the referred person’s ABC case number.
- **SSN:** Displays the referred person’s social security number.

- **REFERRAL STATUS:** Displays the person's status. Valid statuses are:

Exempt	Person is exempt from PROMISE JOBS. Current JOBS code is "1."
Inactive	Person is not actively referred to PROMISE JOBS. Current JOBS code is "X".
Applicant	Person is applying for FIP. Current JOBS code is "3".
Hardship applicant	Person has used 60 months of FIP and is applying for a six-month hardship exemption period. Current JOBS code is "4".
Applicant with LBP	Person has an active LBP and is applying for FIP. Current JOBS code is "U".
Hardship applicant with LBP	Person has an active LBP, has used 60 months of FIP, and is applying for a six-month hardship exemption period. Current JOBS code is "W".
Participant	Person is receiving FIP, or is a parent receiving for children in the home. with JOBS code is "8". FIP status is "A," "B," "C" or status code is "F" or "I" with an "in-home" indicator of "Y."
Participant/hardship	Person has used 60 months of FIP and is eligible for a six-month hardship exemption period. Current JOBS code is "7". FIP status is "A," "B," "C" or status is "F" or "I" with an "in-home" indicator of "Y."
- **REFERRAL DATE:** Displays the date of the most recent "original" referral or "re-referral."
- **REFERRAL NAME:** Displays the name of the referred person.
- **DATE OF BIRTH:** Birth date of the referred person.
- **MINOR PARENT?:** Indicates whether the person's minor parent situation status code in the MINOR field on the ABC TD03 screen is a "4."

Yes	Person is coded "4" in ABC, indicating that the person is living in a three-generation FIP household.
No	Person is not coded "4" in ABC, indicating the person either is: <ul style="list-style-type: none"><li>▪ Not a minor parent, or</li><li>▪ A minor parent who is living independently or with self-supporting parents, a legal guardian or a nonparental relative or who has been married).</li></ul>
- **TWO PARENTS ON FIP?:** Indicates if both parents are on FIP.

Yes	Case aid type is "35-0" on the ABC TD01 screen.
No	Case aid type is not "35-0."
- **FIP STATUS:** Displays the current FIP status of the referred person and is updated in real time. When an IM worker makes entries to activate FIP on a closed case, the FIP STATUS field will immediately show ACTIVE on the PJCase Person screen.

- **CASE APPLICATION DATE:** Displays the date of the most recent FIP application if the person has an active individual FIP status.  
  
NOTE: When an IM worker makes entries to activate FIP on a closed case, the FIP STATUS will immediately show ACTIVE on the PJCase Person screen. However, the CASE APPLICATION DATE field will not display the date until after the next nightly batch processing.
- **EFFECTIVE DATE:** Displays the effective date if the person has an active individual FIP status following the nightly ABC update.  
  
NOTE: When an IM worker makes entries to activate FIP on a closed case, the FIP STATUS will immediately show ACTIVE on the PJCase Person screen. However, the EFFECTIVE DATE field will not display the date until after the next nightly batch processing.
- **IS THERE AN ACTIVE LBP?:** Indicates whether this person is the one who chose the active LBP.  
  
Yes      This person chose the active LBP.  
  
No        This person did not choose the active LBP. The person is active on another person's LBP, but is not the person who chose the LBP.
- **SERVICING AGENCY:** Identifies the agency providing PROMISE JOBS services.  
  
IWD      Iowa Workforce Development
- **CURRENT JOBS CODE:** Displays the person's current JOBS referral code. Valid referral codes are:  

	<b>Description</b>
I	Exempt
3	Mandatory applicant
4	Mandatory, hardship applicant
U	Mandatory applicant with an LBP
W	Mandatory hardship applicant with an LBP
8	Mandatory participant
7	Mandatory participant with a hardship
X	Unknown or not active
- **ACTIVE FIA DATE:** Displays the date that the person signed an FIA. PROMISE JOBS enters this date using options in the FIA MENU. The date remains entered as long as FIP remains active and the person's referral status remains mandatory.  
  
The system removes the date if:
  - FIP is canceled or denied; or
  - The person's referral status is changed from "mandatory" to "exempt" or to "not active."

If FIP is canceled for failure to return a complete *Review/Recertification Eligibility Document* (RRED), the system will not remove the date when the cancellation occurs. If FIP is not reinstated by the second day of the next month, the system will remove the active FIA date at that time.

If FIP is canceled and is later reinstated or reopened without an application, the system will return the previous active FIA date to the field.

When a FIP application was denied but is later approved, the system will use the previously stored active FIA date except when the case was previously pended and is being re-pended.

NOTE: If an FIA is renegotiated and there has been no break in assistance, PROMISE JOBS does not update this field with the new date. The original active FIA date still applies.

If there has been a break in assistance of one month or less and the FIA is reinstated, PROMISE JOBS sends form 470-3300, *Your Family Investment Agreement Reminder*, and a copy of the existing FIA to the applicant to “reinstate” the existing FIA. The FIA is not changed or resigned. PROMISE JOBS should re-enter the original start date of the existing FIA.

If there has been a break in assistance of one month or less, and the existing FIA is amended or a new FIA is signed, PROMISE JOBS enters the date that the new or amended FIA is signed.

If there has been a break in assistance of more than one month, PROMISE JOBS updates the ACTIVE FIA DATE field using the FIA MENU with the new date the FIA is signed.

- **INDV NEG DATE:** Displays the last day of FIP eligibility from the TD03 FIP DATE field in ABC when the person is inactive for FIP.
- **LAST CASE READING DATE:** Displays the date the case was pulled for the random sample PJCase reading tool. Date is displayed in MM-DD-CCYY format only when the case has been pulled.
- **DISASTER IND:** Coding indicates if the person is a victim of a Department-declared disaster. Currently the field is used only for two hurricane disasters.

Blank	No
K	Katrina victim
R	Rita victim

- **WEP/CS HOURS LIMIT:** Displays the maximum monthly number of hours of participation in work experience or community service for all FIA-responsible people in the family.
- **MONTH FOR WEP/CS:** Displays the month and year for which the WEP/CS HOURS LIMIT applies.
- **SINGLE PARENT W/CHILD UNDER 6:** Displays:

Y	When the referred person is a single parent with a child under the age of 6.
N or blank	When the referred person does not have a child under the age of 6 or is not a single parent household.



- **ACTIVELY SELF-EMPLOYED:** Indicates whether or not there is self-employment income on the BCW2 screen in ABC. Valid values are:
  - Y Self-employment income is present on the BCW2 screen.
  - N or blank Self-employment income is **NOT** present on the BCW2 screen.
- **PJOBS CASEWORKER:** Identifies the PJ worker by:
  1. **AGENCY.**
    - I IWD – Iowa Workforce Development
  2. **COUNTY.** This field displays either the client’s county of residence or the county of the PJ worker.

PJCase automatically populates this field with the residence county from the TD01 CO RES FIELD of the person’s ABC case and updates the entry when an IM worker changes the entry in ABC.

The system allows the PJ worker to assign the PJCase Person records of referred people to the worker’s own county and worker ID.
  3. **WORKER ID.** PJ SDR Mailbox or PJ Worker ID. (This field allows PJ staff to make an entry.)

PJCase populates this field with the four-character identifier designated for the SDR Mailbox of the person’s county of residence. Regional mailbox IDs begin with “MB” and end with two-digits to define the SDR number. For example, the mailbox ID for SDR 01 = MB01.

Once a referred person is assigned to a PJ worker, the worker updates the PJCase Person records to the correct worker ID (STDK ID) and county.
  4. **WORKER NAME (F/L).** The information displayed in this field is determined by the following:
    - If COUNTY and WORKER ID entries are system-determined, the county name appears twice in this field.
    - If PJ staff enter the COUNTY and WORKER ID, the name of the assigned PJ worker is displayed in this field.
  5. **PHONE #.** The phone number displayed is determined by the following:
    - If COUNTY and WORKER ID entries are system-determined, the phone number for the designated IWD county office appears in this field.
    - If PJ staff enter the COUNTY and WORKER ID, the phone number of the worker is displayed in this field.

- **DHS IM CASEWORKER:** Identifies the IM worker.  
AGENCY                    4  
COUNTY                 Displays county number from the CO/WKR field on the ABC TD01 screen.  
WORKER ID               Displays the four-character worker number of the IM worker assigned to the case, as indicated in the CO/WKR field on the ABC TD01 screen.  
WORKER NAME           Displays the name of the IM worker  
PHONE #                 Displays the phone number of the IM worker.

The PJCase person screen contains the following action buttons:

- **UPDATE PJ WORKER:** This button is visible only for PJ workers. The button is used to update the PJCase person screen with the worker's ID (STDK ID), once the case is assigned to an ongoing PJ caseworker.
- **LBP START:** Select to start an LBP for the referred person. This action is available to PJ staff only.
- **LBP STOP:** Select to stop an active LBP chosen by the PJCase person. This action is available to both IM and PJ staff.
- **LBP INFO:** Select to view status and information regarding an active or inactive LBP **chosen by** the PJCase person. This action is available to both IM and PJ staff.
- To view an LBP that includes the referred person but was chosen by another person, access LBP INFO from the PJCase Main Menu instead of the PJCase Person screen.
- **HISTORY:** Select this action to view a history of referral changes for the person. This action is available to both IM and PJ staff.
- **PERSONS ON REFERRAL:** Select this action to view the Persons on Referral screen. This action is available to both IM and PJ staff.



The Persons on Referral screen lists the referred person and that person's dependents. It may also incorrectly display the following people:

- The referred person's spouse, if there is an LBP, or
- Dependents that have dropped off FIP since the referral was made, or
- People who have social security numbers of all nines or zeros if PJ has added them in order to pay an expense.

- **EXPENSES:** Select to issue expense allowance payments for the referred person. Available to PJ staff only.
- **FIA MENU:** Select to access the FIA Menu screen to record a mandatory FIP applicant’s completion or failure in signing an FIA when the applicant has **not** chosen an active LBP. Available to PJ and HHS Policy staff.
- **PJCASE MAIN MENU:** Select to return to the PJCase Main Menu. Available to both IM and PJ staff.
- **SELF-EMP INCOME:** Select to view the Self-Employment Income screen, which displays up to an 18-month history of self-employment by benefit month. If the person doesn’t have self-employment, error message 5012, “No self-employment income information found for this referral,” is displayed.
- **INVOICE RETURN:** Obsolete button.

### **LBP Display Screen**

An LBP Display screen gives specific information regarding each LBP imposed, whether active or inactive. The screen identifies the person who chose the LBP and lists all people included.

Both IM and PJ staff use this screen to:



- View information regarding an active or inactive LBP.
- View a history of all actions taken by PJ or IM staff on the LBP.
- Make an entry to stop an LBP.
- Refresh all transactions made on the LBP in the current day.

PJ staff use this screen to record that a person abandoned an attempt to reconsider the LBP.

### **Accessing the LBP Display Screen**

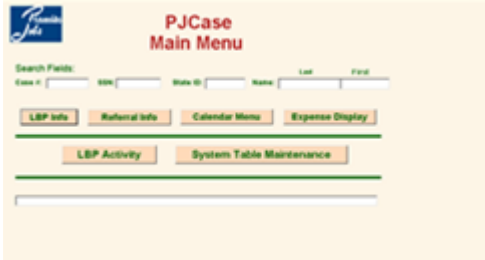
To access the LBP Display screen, follow these steps:

Step	Action
1	 <p>On the PJCase Main Menu, enter either the person’s case number, social security number, state identification number, or name in the applicable SEARCH field and click on LBP INFO.</p> <p>If there is one LBP, the system displays the LBP Display screen.</p> <p>If there is more than one LBP, the system displays the LBP List screen. Go to Step 2.</p>

Step	Action
2	 <p>On the LBP List screen, enter an “X” in the DISPLAY? column next to the applicable LBP and select DISPLAY LBP. The system displays the LBP Display screen.</p> 

The LBP Display screen contains the following fields with information regarding the LBP and the person who chose it:

- **LBP STATUS:** Displays whether the LBP is active or inactive.
- **SSN:** Displays the person’s social security number.
- **STATE ID:** Displays the state ID of the person.
- **CASE ID:** Displays the person’s ABC case number.
- **NAME:** Displays the name of the person
- **LBP START DATE:** Displays the effective date of the LBP.
- **LBP TYPE:** Displays the LBP type: normal, partial, or individual.

Normal

The person who chose the LBP is:

- The parent in a one-parent household, or
- A parent in a two-parent household with at least one common child on FIP.

Partial

The person who chose the LBP is:

- A minor parent who is receiving FIP with the person’s adult parent or relative, or
- A parent in a household that contains two married parents with no common child on FIP.

- Individual            The person who chose the LBP is:
- A needy relative, or
  - An incapacitated stepparent, or
  - A child referred to PJ for not attending school full time.
- **FIRST/SUBSEQUENT:**
- First                    The person either has not chosen an LBP before, or any previous LBP was started in error.
- NOTE: While a first LBP is active, the person can reconsider by signing an FIA.
- Subsequent            The person or another parent in the home has chosen an LBP before the displayed LBP.
- NOTE: While a subsequent LBP is active, the person cannot reconsider until the six-month period of ineligibility ends. (See the field description for **PERSON CAN RECONSIDER AFTER:**.) When the six-month period ends, the person can reconsider by signing an FIA and completing 20 hours of activity.
- **PERSON CAN RECONSIDER AFTER:** This field will display a date or be blank.
- If a date is present, the LBP is an active subsequent LBP and the person cannot reconsider until after this date.
  - If the field is blank, the LBP either is inactive or is an active first LBP.
- **CHOICE DATE:** Displays the date that PJ determined that the person chose the LBP.
- **RECONSIDERATION PENDING SINCE:** When a person in an active LBP is in the process of reconsidering the LBP, this field displays the date that the IM worker changed the person's JOBS code to "U," or "W."
- **PROCESS DATE:** Displays the date the PJ worker made entries to start the LBP.
- **FAILURE REASON:** Displays the code relating to the failure reason. Current codes are:
- A     Did not make appointment.
  - B     Did not keep appointment.
  - C     Did not complete orientation.
  - D     Did not complete assessment.
  - E     Did not sign an FIA.
  - F     Abandoned the FIA.
  - G     Did not verify work hours.
  - H     Did not renegotiate an FIA after previous FIA ended.
  - I     Did not participate in FIA progress review.
  - K     Did not verify hours of participation in activities other than work.
- **FIA EXISTED BEFORE LBP CHOICE:** Displays either a "Y" for yes or an "N" for no.
- **DATE FIA SIGNED TO RECONSIDER:** If a date is present, it is the date the person signed an FIA to reconsider the LBP.

- **STOP INFORMATION:**
  - **STOP DATE.** Displays the date that the LBP was stopped or is blank.
    - If there is a date in this field, the LBP is stopped on this date.
    - If the field is blank, the LBP is active. EXCEPTION: If the STOP REASON field contains an “E” and the LBP STATUS field displays “inactive,” the LBP expired under a policy that existed before 06-01-1999. Consider the LBP as not active.
  - **STOP REASON.** This field will contain an entry if the LBP is not active. The stop reason codes are:
    - A Appeal (IM only)
    - B Child left the home (IM only)
    - C LBP in error (PJ and IM)
    - D Person who chose the LBP left the home (IM only)
    - E LBP expired under former policy, or stopped under former policy as the person who chose moved to a control county/case
    - I Administrative stop for individuals (IM only)
    - R Person who chose the LBP completed significant contact (PJ only)
    - W Administrative stop for entire LBP (IM only)
    - Z System-entered. LBP was initially stopped pending appeal and was later reactivated with a new effective date.
  - **STOP AGENCY/COUNTY/WORKER.** Indicates who stopped the LBP.
- **APPEAL INFORMATION:** If both of the fields are blank, the LBP has not been stopped pending an appeal.
  - **APPEAL DATE.** If the LBP is stopped for reason code “A” (pending an appeal), this field displays the date that the appeal was filed as entered by the IM when the LBP was stopped.
  - **APPEAL REACTIVATE DATE.** System-determined. When an LBP is stopped pending an appeal, PJCase determines the APPEAL REACTIVATE DATE will be a new LBP effective date when or if the LBP is reactivated. The field will display “New.”

The following action buttons are available on the LBP Display screen.

- **LBP TRANS HISTORY:** Select this action to view a history of all actions taken by PJ or IM staff on the LBP. This action is available to both IM and PJ staff.
- **ABANDON RECONSIDERATION:** Select this action to record that a person has abandoned reconsideration of the LBP. This action is available only to PJ staff. This choice is visible on the screen only if the user logged in under agency code “I,” so IM staff will not see it.
- **LBP STOP:** Select this action to make entries to stop an LBP. This action is available to both IM and PJ staff.
- **REFRESH LBP:** Select this action to make entries to refresh all transactions made on the LBP on the current day. See [Refreshing an Entry](#) for more information. This action is available to both IM and PJ staff.

- **CANCEL:** Select this action to cancel your entry to return to the Main Menu. This action is available to both IM and PJstaff.

The bottom of the page displays each person included in the LBP at the time it was started. If the LBP is not active for the person, a STOP REASON and STOP DATE will display.

If a person was included in an LBP at the time the LBP was started, and the person is no longer attached to the ABC case that the LBP is assigned to, only the person's state ID will display. The display will say "Person not on case" in the name field. The LBP should be stopped for a person who is no longer attached to the case when the person is no longer in the home.

## **Stopping an LBP**

Stopping an LBP is the responsibility of either the IM worker or the PJ worker, depending on the situation. See [4-1](#), Stopping a Limited Benefit Plan, or [PROMISE JOBS Provider Manual](#), Stopping a Limited Benefit Plan, for more information.

### **LBP - Stop Screen**

Entries are made on the LBP – STOP screen to stop an LBP. The fields are described below:

- **SSN:** Displays the social security number of the person who chose the LBP.
- **STATE ID:** Displays the state identification number of the person who chose the LBP.
- **CASE #:** Displays the ABC case number of the person who chose the LBP.
- **NAME:** Displays the name of the person who chose the LBP.
- **LBP TYPE:** Displays the LBP type: normal, individual or partial.

Normal

The person who chose the LBP is:

- The parent in a one-parent household, or
- A parent in a two-parent household with at least one common child on FIP.

Partial

The person who chose the LBP is:

- A minor parent who is receiving FIP with the person's adult parent or relative, or
- A parent in a household that contains two married parents with no common child on FIP.

Individual

The person who chose the LBP is:

- A needy relative, or
- An incapacitated stepparent, or
- A child referred to PJ for not attending school full time.

- **FIRST/SUBSEQUENT:** Indicates whether the LBP chosen by the person entered is a first or subsequent.

First	The person either has not chosen an LBP before, or any previous LBP was started in error.  NOTE: While a first LBP is active, the person can reconsider by signing an FIA.
Subsequent	The person or another parent in the home has chosen an LBP before the displayed LBP.  NOTE: While a subsequent LBP is active, the person cannot reconsider until the six-month period of ineligibility ends. (See the field description for <b>PERSON CAN RECONSIDER AFTER:</b> .) When the six-month period ends, the person can reconsider by signing an FIA and completing 20 hours of activity.
- **START DATE:** Displays the LBP effective date.
- **PERSON CAN RECONSIDER AFTER:**
  - If the LBP is a first LBP, this field will be blank.
  - If the LBP is a subsequent LBP, this field displays the last day of the six-month period of ineligibility. The person who chose the LBP cannot begin action to reconsider the LBP until this date has expired.
- **LBP PROCESS DATE:** Displays the date that the LBP start date entry processed.
- **FIP STATUS:** Displays the current FIP status of the person who chose the LBP. The code definitions are:

A	Opened, due to application (either for case or adding a person)
B	Reinstated
C	Reopened, is not an application procedure
D	Pended
F	Excluded adult (not sanctioned)
H	Stepparent or self-supporting parent in minor parent case
I	Sanctioned
M	Denied
N	Canceled
S	Never opened (system-generated)



- **STOP REASON:** Dropdown box containing the possible reasons the LBP is being stopped. PJ workers can use only reason code “C” or “R.” IM workers cannot use reason code “R.” The options displayed are:

A Appeal. Entered by **IM** only. Use code “A” to stop the entire LBP when an appeal is filed timely, according to

4-J, [When an Appeal of a Limited Benefit Plan Is Filed](#) for more information.

B Child left the home. Entered by **IM** only. Use code “B” to stop the LBP for a child when the child in an LBP chosen by a parent or needy relative leaves the home. The LBP remains in place for the parent or relative and any members who still live with that person.

When the child is a minor parent, use code “B” to stop the LBP for the minor parent and the minor parent’s child when the LBP was chosen by a parent or needy relative and:

- The minor parent and minor parent’s child leave that person’s home and become eligible on another case, or
- The minor parent turns 18, or is 18 and completes high school, and applies for a separate FIP case, or
- The minor parent applies for a separate FIP case after the minor parent and child are canceled due to the parent or relative’s LBP. Consider the minor parent as living in the home of a self-supporting parent in this situation.

See 4-J, [To Whom the Limited Benefit Plan Is Applied and Minor Parents Living With FIP Parent](#) for more information.

C LBP started in error. Entered by either **IM** or **PJ**.

IM uses code “C” to stop an entire LBP when:

- The person who chose the LBP was referred to PJ in error because the person was exempt due to the receipt of SSI, school attendance, or alien status when the LBP was imposed.
- The final appeal decision reverses the LBP.

PJ uses code “C” to stop an entire LBP when they determine the LBP was started in error.

**Do not** use code “C” to stop an LBP when a person becomes exempt after the notice is issued imposing an LBP. Use code “W.”

See 4-J, [Stopping a Limited Benefit Plan](#) and PROMISE JOBS Provider Manual, [Stopping a Limited Benefit Plan](#) for more information.

- D The person who chose the LBP left the home. Entered by **IM** only. Use code “D” to stop an LBP for the remaining parent and children when the parent who chose the LBP leaves the home.

The LBP remains in place for the parent who chose the LBP and any children living with that parent. See [4-J](#), *Limited Benefit Plan*, *Limited Benefit Plan Variations*, *Two-Parent Households*, and *Stopping a Limited Benefit Plan* for more information.

- I Administrative stop for individuals. Entered by **IM** only. Use code “I” to stop an LBP for a person in the LBP when the LBP needs to remain active for the person who chose the LBP and neither reason code “B” or “D” applies. Some situations where code “I” applies:

- A person on the case is incorrectly included in the LBP.
- An appeal is filed of a notice canceling FIP due to an LBP that is in effect for the person who chose the LBP and possibly others. See [4-J](#), *To Whom the Limited Benefit Plan is Applied and Stopping a Limited Benefit Plan*, or [PROMISE JOBS Provider Manual](#), *Stopping a Limited Benefit Plan*, for more information.

The LBP must remain in effect for the person who chose it and for any others previously canceled due to the LBP.

On June 1, 2005, a parent who chose an LBP effective January 1, 2004, returns to the home of the other parent and children, who are on FIP. On June 2, IM sends a notice to cancel FIP effective July 1, 2005. The household files an appeal on June 7, 2005.

The IM worker uses reason code “I” to stop the LBP for the parent and children who had been receiving FIP and makes ABC entries to reinstate FIP for them. The LBP remains active for the parent who chose the LBP.

- R Person reconsidered. **PJ** only. Use code “R” to stop an LBP when the person who chose the LBP reconsiders (signs an FIA and if a subsequent LBP, completes 20 hours of PROMISE JOBS activity).

See [4-J](#), [Reconsidering a Limited Benefit Plan](#) and PROMISE JOBS Provider Manual, [Reconsidering an Active Limited Benefit Plan](#), for more information.

- W Administrative stop for entire LBP. **IM** only. Use code “W” to stop the entire LBP when no other stop reason applies. Code “W” applies when the LBP was started according to policy but needs to be temporarily or permanently stopped due to a change in the person’s circumstances. Some situations to use reason code “W”:

- Person becomes exempt after the notice is issued to impose the LBP. See [4-J](#), *When a Mandatory Participant Can Become Exempt* for more information.
- Needy relative: chooses an LBP and later reapplies for **the needs of the children only**. See [4-J](#), [Stepparent or Needy Specified Relative](#) for more information.:

If the relative later reapplies for the relative’s own needs and the LBP has been

temporarily stopped using code “W,” use the LBP Reactivate function to reimpose the LBP. To get FIP again, the relative must sign an FIA and if a subsequent LBP, complete 20 hours of PROMISE JOBS activity.

**Do not** use code “B” or “D” to stop the LBP for the children when a needy relative chooses an LBP and later reapplies for the needs of the children only **unless** the children no longer live with the relative. If you do, the Eligibility Tracking System (ETS) will not properly count the relative’s use of the 60-month limit.

When a child is receiving FIP on a case with an adult who has a FIP status code “I” and an In-Home code of “Y” on the ABC TD03 screen, ETS counts the FIP payments towards the adult’s 60-month limit. The count is appropriate when the adult is a parent, but it is not appropriate when the adult is a specified relative. Temporarily stop the entire LBP using reason code “W.”

See 4-J, [Stopping a Limited Benefit Plan](#) and PROMISE JOBS Provider Manual, [Stopping a Limited Benefit Plan](#) for more information.



- Z **System-entered only.** The LBP was initially stopped pending an appeal and later reactivated with a new effective date.
- **DATE FIA SIGNED TO RECONSIDER:** Only PJ staff can make an entry in this field. Entry is required when the STOP REASON entry is “R.” Enter the date the person who chose the LBP signed an FIA to reconsider. Enter the date in MM-DD-CCYY format.
  - **APPEAL DATE:** Only IM staff can make an entry in this field. Entry is required when the STOP REASON entry is “A.” Enter the date that the appeal request was filed. The system compares the APPEAL DATE entered to the NOTICE DATE and the LBP START DATE to make certain that the LBP should be stopped so benefits can continue pending the appeal decision.
- When an LBP previously stopped with reason A is reactivated, PJCase will determine a new LBP START DATE.

The LBP – Stop screen contains these two action buttons:

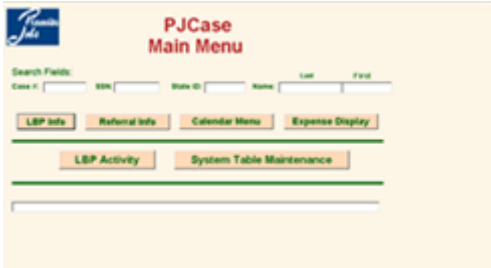

- **STOP LBP:** Select this button to continue your stop entry. The system will edit your entries.
    - If your entry is successful, the system displays the LBP Stop Confirmation screen.
    - If your entry is not successful, the system displays an error message in red text.
- NOTE: If the IM selects the STOP REASON code “B,” “D,” or “I” and clicks the STOP LBP button:
- The system displays a message to prompt you to select the person to be stopped, and the screen populates with all people included in the LBP other than the person who chose the LBP.
  - Click in the box in the STOP? field next to each appropriate person to enter an “X” in the field and include that person in the Stop LBP.
- **CANCEL:** Select this button to stop your entry and to return to the PJCase Main Menu.

### Steps to Stop an LBP

Follow the instructions below to stop an LBP. To stop an LBP, you must access the LBP - Stop screen. IM workers can follow three different paths to access the screen while PJ workers have two paths available to follow. Both IM and PJ workers can follow these steps to access the LBP - Stop screen.

Step	Action
1	 <p>On the PJCase Main Menu, enter the person’s case number, social security number, state identification number, or name in the appropriate search field. Select LBP INFO. If there is more than one LBP, the system displays the LBP List screen. Go to Step 2. If there is only one LBP, the system displays the LBP Display screen. Go to Step 3.</p>
2	 <p>On the LBP List screen, enter an “X” in the DISPLAY? column next to the applicable LBP and select DISPLAY LBP. The system displays the LBP Display screen.</p>
3	 <p>On the LBP Display screen, click on the LBP STOP button. The system displays the LBP - Stop screen. Follow the instructions in the table under the heading, <a href="#">Completing Stop LBP Function From the LBP – Stop Screen</a>, to complete the Stop LBP function.</p>

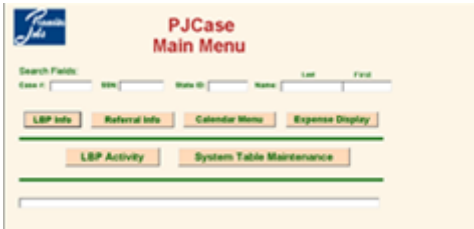
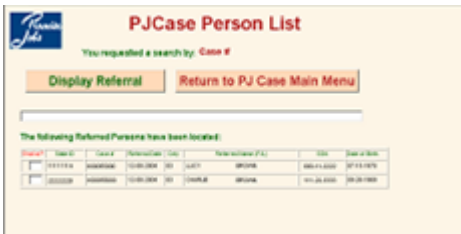
Both IM and PJ workers can follow these steps to access the LBP - STOP screen.

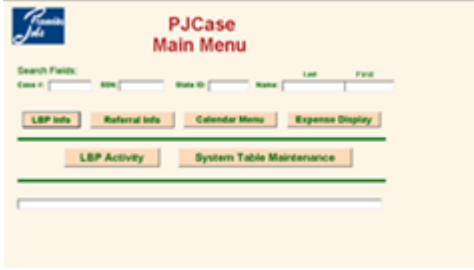
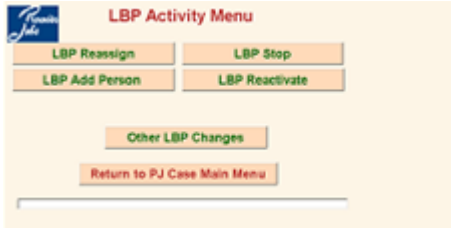
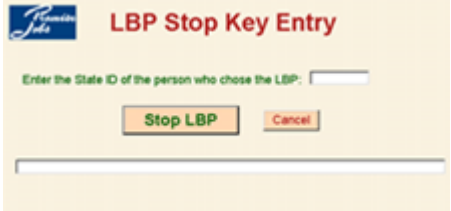

Step	Action
1	 <p>On the PJCase Main Menu screen, enter the person’s case number, social security number, state identification number, or name in the applicable search field. Select REFERRAL INFO.</p> <p>If there is more than one referred person on the case, the PJCase Person List screen will be displayed. Go to Step 2.</p> <p>If there is only one referred person on the case, the PJCase Person screen will be displayed. Go to Step 3.</p>
2	 <p>On the PJCase Person List screen, enter an “X” in the DISPLAY? column next to the name of the person who chose the LBP. Select DISPLAY REFERRAL. The system displays the PJCase Person screen.</p>
3	 <p>On the PJCase Person screen, click on the LBP STOP button. The system displays the LBP - Stop screen. Follow the instructions in the table under the heading, <a href="#">Completing Stop LBP Function From the LBP – Stop Screen</a>, to complete the Stop LBP function.</p>

Only IM workers can access the LBP - Stop screen by following these steps.

Step	Action
1	 <p>On the PJCase Main Menu, click on the LBP ACTIVITY button. The system displays the LBP Activity Menu screen.</p>
2	 <p>Click on the LBP STOP button. This will display the LBP Stop Key Entry screen.</p>
3	 <p>Enter the state ID of the person who chose the LBP and select STOP LBP. This displays the LBP - Stop screen. Follow the instructions in the next table to complete the Stop LBP function.</p>

### Completing Stop LBP Function From the LBP - Stop Screen

Once you have reached the LBP - Stop screen, follow these steps to complete the Stop LBP function.

Step	Action
1	 <p>On the LBP - STOP screen, use the dropdown box in the STOP REASON field to choose the reason that applies.</p> <p>NOTE: PJ workers can use only reason code “C” or “R.” IM workers cannot use reason code “R.”</p>
2	<p>IM staff:</p> <ul style="list-style-type: none"> <li>▪ If you select code “A,” also enter the date the appeal was filed in the APPEAL DATE: field.</li> <li>▪ If you select code “B,” “D,” or “I,” select STOP LBP. The system will display each person included in the LBP. Click on the STOP? field next to each person who is no longer affected by the LBP.</li> </ul> <p>PJ staff: If you select code “R,” enter the date that the FIA was signed in the DATE FIA SIGNED TO RECONSIDER field in the MM-DD-CCYY format.</p>
3	<p>Select the STOP LBP button. The system will display the LBP - Stop Confirmation screen.</p>
4	 <p>Select either:</p> <ul style="list-style-type: none"> <li>▪ COMPLETE LBP STOP, to process the entry, or</li> <li>▪ CANCEL, to stop processing the entry and return to the PJCase Person screen.</li> </ul>

### **Result of Stopping an LBP**

When an IM or PJ worker confirms an LBP stop entry, the following events occur **immediately**:

- The LBP Display screen displays the LBP as stopped with the entered reason and the date the stop entry processed. When an LBP is stopped using reason A – Appeal, the LBP Display screen will also display the worker entered appeal date and “New” as the APPEAL REACTIVATE DATE.
- The system sends an email to either the IM worker or the PJ worker based on who made the LBP stop entry.
- The ABC system no longer displays LBP information in the TD03 screen for the people who were in the LBP, unless the people are in another active LBP on the case. (See [Stopping One LBP for a Household With Multiple LBPs](#) for more information.)
- The system changes the FIP status code of the people who were in the LBP from “I” to “N,” unless:
  - The person has an “I” status code for reasons other than the LBP. The system does not change the status code from “I” to “N” when the person’s FIP notice reason code is 203, 310, 311, 312, 313, 908 or 995;
  - The person did not have an “I” status code yet, as the stop entry was made before the effective date of the LBP; or
  - The person is in another active LBP on the case.
- When the person who chose the LBP has a JOBS code of “U,” the system will change the code to:
  - “8” or “K” if FIP is active; or
  - “X” if FIP is not active.
- If a date existed in the RECONSIDERATION PENDING SINCE field in LBP Display, this date is removed.
- The system records the transaction in the LBP Transaction History.

With some stop reasons entered by IM or PJ, the system automatically issues a *Notice of Decision* when processing the entry as indicated in the following table. The notice is sent to the household on the next working day.

If a *Notice of Decision* is needed, and the system does not send a notice, make an entry in ABC to issue the notice or manually issue the notice.



Stop Reason	System–Generated Notice Reason	
	Normal LBP	Individual or Partial LBP
A	267	867
B	872	872
C	253 (1 <sup>st</sup> ) or 254 (subs)	853 (1 <sup>st</sup> ) or 854 (subs)
D	None	None
I	None	None
R	265	865
W	None	None

Exceptions to the table:

B, Child leaves the home      The system generates a notice **only** when the child is active for FIP on a case other than the case with the LBP. The notice is sent to the active FIP case.

Two parents choose an LBP      When both parents in a two-parent household have an active normal LBP, and entry is made to stop one of the LBPs, the system does not send a notice, as one LBP remains active. A notice will be sent if the other LBP is later stopped with a reason that causes a system-generated notice.

See [14-B-Appendix](#) for the text of FIP LBP notices.

When FIP is still active for the people who are in the LBP when the stop entry is made, the system recalculates FIP without the effect of the LBP and sends a notice when benefits change. This situation may occur when the LBP is stopped before the ABC cutoff date before the effective date of the LBP.

An entry to stop an LBP does not reactivate FIP benefits. The entry only inactivates the LBP. If FIP is not active, the IM worker needs to make entries in ABC to activate FIP if all eligibility requirements are met.

**Stopping One LBP for a Household with Multiple LBPs**

When more than one person on a case chooses an LBP, PJCase contains a separate record for each LBP. The LBP List screen will display a separate row to record the choice of each person. Each parent’s LBP needs to be managed separately, depending on household circumstances.

The following example shows an LBP List on a case with two people who have each chosen an LBP. Both LBPs are active as the STOP DATE/REASON field for both is blank:

**Promise Jobs**

## LBP List

You requested a search by: **Case #**

Display LBP
Return to PJ Case Main Menu

---

The following LBPs have been located:

Display?	State ID	LBP Status	Case #	Chooser Name (F/L)	SSN	Birth Date	Start Date	StopDate/Reason	Type	F/S
<input type="checkbox"/>	2020202A	A	P010100000	CHARLIE JONES	156-00-1234	07-04-1975	07-01-2005		N	F
<input type="checkbox"/>	3030303B	A	P010100000	GRETCHEN HANSEN	157-11-4321	03-05-1979	07-01-2005		N	F

If entry is made to stop one LBP, PJCase will display the stopped LBP with an inactive status and a stop date and reason.

The other LBP remains active. PJCase will display the LBP as active with nothing in the STOP DATE/REASON field unless the person has been individually stopped on the active LBP. People included in the active LBP will still have an “I” individual FIP status code and LBP data in the “LBP” field of TD03.

In the following example, Gretchen’s LBP is stopped and Charlie’s remains active:

**Promise Jobs**

## LBP List

You requested a search by: **Case #**

Display LBP
Return to PJ Case Main Menu

---

The following LBPs have been located:

Display?	State ID	LBP Status	Case #	Chooser Name (F/L)	SSN	Birth Date	Start Date	StopDate/Reason	Type	F/S
<input type="checkbox"/>	2020202A	A	P010100000	CHARLIE JONES	156-00-1234	07-04-1975	07-01-2005		N	F
<input type="checkbox"/>	3030303B	I	P010100000	GRETCHEN HANSEN	157-11-4321	03-05-1979	07-01-2005	08-19-2005 R	N	F

If both LBPs need to be stopped, the IM or PJ worker must make separate entries by accessing the stop entry screens for each person who chose an LBP. Once the second LBP is stopped, the system will process the entry as described at [Result of Stopping an LBP](#).

1. Two parents choose an LBP, one parent leaves the home:  
Mr. A and Mrs. A each chooses a first LBP effective February 1. On April 5, Mrs. A reapplies for FIP. She reports that Mr. A left the home.  
  
On the day of the interview, the IM worker pends the application in ABC and refers Mrs. A to PJ with a “U” JOBS code. The IM worker also accesses PJCase to make an entry to stop Mr. A’s LBP for Mrs. A and the children using reason code “D” (chooser left the home).  
  
PJCase sends an email to PJ. Mr. A’s LBP remains active for him only. Mrs. A’s LBP remains active for everyone.  
  
On April 13, Mrs. A signs an FIA. The PJ worker makes an entry to stop Mrs. A’s LBP. PJCase sends an email to IM. The IM worker determines her FIP eligibility.
2. Two parents choose an LBP, both reconsider: Same scenario as Example 1, except both Mr. and Mrs. A reapply for FIP on April 5.  
  
On the day of the interview, IM pends the application and refers both parents to PJ with a “U” JOBS code. On April 13, both parents sign an FIA. The PJ worker accesses each parent’s LBP and makes a separate entry to stop each LBP. After processing each stop entry, PJCase sends an email to IM.

When one LBP is stopped and the other remains active, PJCase does not issue a *Notice of Decision*. PJCase sends a notice if the second LBP is stopped for a stop reason code other than “W” or “I.” (PJCase never sends a notice when processing an LBP stopped for reason code “W” or “I.”)

## PJ Expense Screens

IM and PJ workers can view PJ expenses using the Expense Display function. This function displays the expense history either by case number or person identifier (social security number or state identification number). Individual expenses can be selected and viewed in more detail.



**Expense History List**

Searched by : **SID**

Social Security Number: **423697698** Name: **WILLOW BRENDA**  
State ID: **1290949G**

[Return to PJ Case Main Menu](#)

The following Expenses have been located:

Select?	Case #	Mail Date	Billing Period	Amount	Type	CC	PP	Provider
<a href="#">Select</a>	D117420001	07-05-2006	07-10-2006 07-14-2006	\$76.50	A	AB	N	
<a href="#">Select</a>	D117420001	04-27-2006	05-01-2006 05-31-2006	\$700.00	A	VV	N	
<a href="#">Select</a>	D117420001	04-27-2006	05-01-2006 05-01-2006	\$204.20	A	VE	N	
<a href="#">Select</a>	D117420001	01-24-2006	01-19-2006 02-19-2006	\$50.00	A	2B	N	

The Expense History List screen contains the following fields:

- **SEARCHED BY:** Displays the search identifier used by the worker.
- **CASE:** Displays the current case number of the person. This field is visible only when searching by case number.
- **SOCIAL SECURITY NUMBER:** Displays the social security number of the person.
- **NAME:** Displays the person's name.
- **STATE ID:** Displays the state identification number of the person.
- **SELECT?** This field is used to view expenses. Click on the SELECT link to view expenses when an individual expense needs to be viewed in more detail on the Promise Jobs Expense Allowance screen.

The EXPENSE HISTORY LIST screen contains **RETURN TO PJ CASE MAIN MENU** button. Click this button to return to PJCase Main Menu.

The bottom of the screen lists the individual expenses, based on the Mail Date.

Workers can display expenses by Mail Date, Billing Period, Type, or Provider by clicking the gray heading at the top of the appropriate column.

If the Display List entry is highlighted in red, the check has been canceled. If the Display List entry is highlighted in blue, the entry is still awaiting correction to the provider number or waiting for the provider to be added to the Department of Revenue’s vendor file. The blue highlight will disappear once the expense has been corrected by Quality Assurance and released.

Hover your cursor over the codes in the CC (component code) or Type (A) allowance columns to view an explanation of the specific codes.

- The PROMISE JOBS Expense Allowance screen shows more detail about the expense payment. This is a read-only screen, so no changes can be made on this screen. The screen contains the following fields:
- **STATE ID:** Displays the state identification number of the person.
- **CASE ID:** Displays the current case number of the person.
- **SSN:** Displays the social security number of the person.
- **CLIENT NAME:** Displays the person’s name in the last name, first name format.
- **REFERRAL CODE:** Displays the person’s current JOBS referral code as follows:
 

IWD	Description
1	Exempt
3	Mandatory applicant
4	Mandatory, hardship applicant
U	Mandatory applicant with an LBP
W	Mandatory hardship applicant with an LBP
8	Mandatory participant
7	Mandatory participant with a hardship
X	Unknown or not active
- **AGENCY:** Displays the worker’s agency code:
 

1	IWD/PROMISE JOBS (includes agencies who subcontract with IWD to provide PJ services)
4	HHS IM worker

- **COUNTY:** Displays the two-digit code that corresponds to the county where the worker's agency office is located.
- **WORKER:** Displays the three- or four-digit worker identification number.
- **AMOUNT:** Displays the dollar amount of the expense.
- **DISASTER IND:** Displays a coding indicating if the person is a victim of a Department-declared disaster. Currently the field is used only for two hurricane disasters.  

Blank	No
K	Katrina victim
R	Rita victim
- **ALLOWANCE TYPE:** Displays the applicable expense allowance code. They are:  

A	Transportation, mileage or actual for PJ; one-time costs such as tires, repairs, etc., for FSSG
B	Tools, PJ and FSSG
C	Uniforms and safety equipment for PJ; uniforms and other clothing needs for FSSG
D	Tuition for PJ
E	Books for PJ
F	Education supplies for PJ
G	Fees, education-related, and birth certificate costs, PJ and FSSG
H	Licensing, certification and testing costs, including travel costs, PJ and FSSG
J	Child care, full-time, PJ and FSSG (30 hours or more weekly)
K	Child care, part-time, PJ and FSSG (less than 30 hours weekly)
L	Transportation, handicapped, for PJ
M	Practicum living costs for PJ (up to \$10 per day)
N	Shelter for FSSG
P	Provider payment for PJ (for parenting classes and PJ family development only)
R	Relocation for FSSG
S	Social services for FSSG
T	Other for FSSG
U	13-15 years old exception to policy for child care
- **TIME PERIOD:** Displays the beginning date of the period that the allowance covers in MM-DD-CCYY format.
- **COMPONENT CODE:** Displays the applicable component code that allows for payment of expenses with PJ funds. The choices are:  

AA	Orientation
AB	Assessment
BA	Job-seeking skills (job readiness)
C	Group job search
E	High school completion
F	GED

G	Adult basic education
H	English as a second language
L	Work experience
MH	Mental health treatment
N	Unpaid community service
OR	Other rehabilitation
PE	Post-secondary classroom training (educational)
PV	Post-secondary classroom training (vocational)
RA	On-the-job training
SA	Substance abuse treatment
TE	Institutional skills training (educational)
TV	Institutional skills training (vocational)
VE	Short-term training (30 to 52 weeks)
VV	Short-term training (less than 30 weeks)
WE	Workplace essentials
10	FSSG
2B	Individual job search
6	Child care for employment
7A	Parenting classes (for 19 and younger)
7B	Parenting classes (for all others)
8A	Family development services (for parents aged 17 or younger)
8B	Family development services (for all others)

- **THRU:** Displays the ending date of the period the allowance covers MM-DD-CCYY format.
- **ENTRY DATE:** Displays the date the expense allowance was entered by the PJ worker.
- **DHS PROCESS DATE:** Displays the date the warrant is released from HHS files to the Department of Administrative Services for actual issuance.
- **MAIL DATE:** Displays the estimated date the expense allowance warrant is mailed. This is two working days after the HHS Process Date.
- **PROVIDER NAME:** Displays the provider name.
- **PROVIDER NUMBER:** Displays the provider's nine-digit federal tax identification or social security number.
- **LOCATION:** Displays the provider location where services are provided.
- **ADDRESS:** Displays the provider's mailing address.
- **NUMBER OF CHILDREN:** Displays the number of children a day care expense allowance covers.
- **CITY:** Displays the provider's city.
- **STATE:** Displays the provider's state.
- **ZIP:** Displays the provider's ZIP code.

- **TYPE:** Displays the applicable vendor types. The vendor types are:
  - C Corporation
  - G Government/nonprofit
  - P Partnership
  - S Sole proprietor
  - U Public service
  - I Individual
- **CODE:** Displays the applicable vendor code. The vendor codes are:
  - E Employer identification number
  - S Social security number
- **DAY CARE PROV TYPE:** Displays the applicable day care provider type codes. This field displays a code only when the ALLOWANCE TYPE field entry is “J” or “K.” The applicable codes are:
  - A Licensed non-relative, center
  - B Registered non-relative, group
  - C Registered non-relative, family
  - E Non-registered non-relative, family
  - F Non-registered non-relative, in home of dependent
  - G Registered relative, group
  - H Registered relative, family
  - J Non-registered relative, family
  - K Non-registered relative, in home of dependent
- **DEP TYPE:** Displays the applicable dependent type code. This field displays a code only when the ALLOWANCE TYPE field entry is “J” or “K.” Valid codes are:
  - A Child of participant
  - B Incapacitated parent
  - C SSI recipient
  - D Foster child
  - E Other
- **DAY CARE RSN:** Displays the day care reason code. This field displays a code only when the ALLOWANCE TYPE field entry is “J” or “K.” Valid codes are:
  - A Work or work related
  - B Education, training

This screen contains the following action buttons:



- **BACK TO LIST** will return you back to the EXPENSE HISTORY LIST screen
- **RETURN TO PJ CASE MAIN MENU**

NOTE: Quality Assurance staff also have a CANCEL RETURNED WARRANT button that they use to cancel returned PJ warrants.

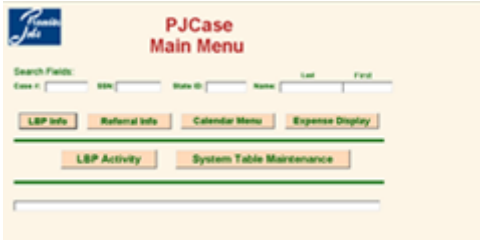

**Viewing PJ Expenses**

Follow these steps to view a PJ expense:

Step	Action																																			
1	<p>On the PJCase Main Menu screen, enter one of these identifiers:</p> <ul style="list-style-type: none"> <li>▪ Case #:</li> <li>▪ SSN:</li> <li>▪ State ID:</li> </ul>  <p>Select EXPENSE DISPLAY to view the Expense History List screen.</p>																																			
2	 <p>The following Expenses have been located:</p> <table border="1" data-bbox="456 1129 846 1209"> <thead> <tr> <th>Case #</th> <th>Expense #</th> <th>Expense Date</th> <th>Expense Amount</th> <th>Expense Type</th> <th>Expense Status</th> <th>Expense Description</th> </tr> </thead> <tbody> <tr> <td>423007690</td> <td>00000001</td> <td>01/01/2008</td> <td>00.00</td> <td>A</td> <td>OK</td> <td></td> </tr> <tr> <td>423007690</td> <td>00000002</td> <td>01/01/2008</td> <td>00.00</td> <td>A</td> <td>OK</td> <td></td> </tr> <tr> <td>423007690</td> <td>00000003</td> <td>01/01/2008</td> <td>00.00</td> <td>A</td> <td>OK</td> <td></td> </tr> <tr> <td>423007690</td> <td>00000004</td> <td>01/01/2008</td> <td>00.00</td> <td>A</td> <td>OK</td> <td></td> </tr> </tbody> </table> <p>To view an expense in more detail, click on the SELECT link to display the PROMISE JOBS Expense Allowance screen. Click on RETURN TO PJCASE MAIN MENU to perform a new search.</p>	Case #	Expense #	Expense Date	Expense Amount	Expense Type	Expense Status	Expense Description	423007690	00000001	01/01/2008	00.00	A	OK		423007690	00000002	01/01/2008	00.00	A	OK		423007690	00000003	01/01/2008	00.00	A	OK		423007690	00000004	01/01/2008	00.00	A	OK	
Case #	Expense #	Expense Date	Expense Amount	Expense Type	Expense Status	Expense Description																														
423007690	00000001	01/01/2008	00.00	A	OK																															
423007690	00000002	01/01/2008	00.00	A	OK																															
423007690	00000003	01/01/2008	00.00	A	OK																															
423007690	00000004	01/01/2008	00.00	A	OK																															
3	 <p>After viewing the expense details select either:</p> <ul style="list-style-type: none"> <li>▪ BACK TO LIST, to return to the PROMISE JOBS Expense Allowance screen to select a different expense, or</li> <li>▪ Return to PJCase Main Menu, to perform a new search.</li> </ul>																																			

## Self-Employment Income Screen

IM and PJ workers can view a history of self-employment income if the person has self-employment income entered on the BCW2 screen in ABC. The screen displays up to 18 months of self-employment income with the most current income at the top of the screen.

Component	Benefit Month	Amount	Weekly Hours	Start Date	End Date
SE	02-2009	\$400.00	14	02-01-2009	
SE	09-2008		30	02-04-2008	09-30-2008
SE	09-2008		06	01-30-2008	09-30-2008
SE	08-2008		30	02-04-2008	09-30-2008
SE	08-2008		06	01-30-2008	09-30-2008
SE	07-2008		30	02-04-2008	09-30-2008
SE	07-2008		06	01-30-2008	09-30-2008
SE	06-2008		30	02-04-2008	09-30-2008
SE	06-2008		06	01-30-2008	09-30-2008
SE	05-2008		30	02-04-2008	09-30-2008
SE	05-2008		06	01-30-2008	09-30-2008
SE	04-2008		30	02-04-2008	

The Self-Employment Income screen contains the following fields:

- **STATE ID:** Displays the state identification number of the person.
- **CASE ID:** Displays the current case number of the person. This field is visible only when searching by case number.
- **SSN:** Displays the social security number of the person.
- **REFERRAL NAME:** Displays the name of the referred person.

The Self-Employment Income screen contains two action buttons:



- **RETURN TO PJCASE PERSON:** Click this button to return to PJCase Person screen.
- **RETURN TO PJ CASE MAIN MENU:** Click this button to return to PJCase Main Menu.



The bottom of the screen lists information regarding the self-employment income, starting with the most current benefit month. The fields displayed are:

- **COMPONENT:** Displays the code “SE” indicating self-employment.
- **BENEFIT MONTH:** Displays the benefit month of the BCW2 that the self-employment income was populated.
- **AMOUNT:** Displays the amount of the self-employment income indicated on the BCW2
- **WEEKLY HOURS:** Displays the system-calculated weekly hours by taking the “amount” divided by the minimum wage.
- **START DATE:** Displays the first month that self-employment is indicated on an BCW2.
- **END DATE:** Displays the first month that self-employment is no longer indicated on a BCW2 minus one month. Example: If the person has been self-employed, but in September the BCW2 no longer shows income, the END DATE would be August (September minus one).

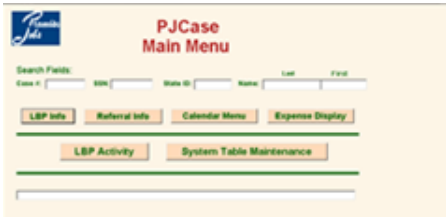
### Viewing Self-Employment Income

To access the Self-Employment Income screen, follow these steps:

Step	Action
1	 <p>On the PJCase Main Menu screen, enter the person’s case number, social security number, state identification number, or name in the applicable SEARCH field. Select REFERRAL INFO.</p> <p>If there is more than one referred person on the case, the PJCase Person List screen will be displayed. Go to Step 2.</p> <p>If there is only one referred person on the case, the PJCase Person screen will be displayed.</p>
2	 <p>On the PJCase Person List screen, enter an “X” in the DISPLAY? column next to the name of the person who chose the LBP. Select DISPLAY REFERRAL. The system displays the PJCase Person screen.</p>

Step	Action
3	 <p>On the PJCase Person screen, select SELF-EMP INCOME to move to the Self-Employment Income screen.</p>
4	 <p>When finished viewing the self-employment income, select either:</p> <ul style="list-style-type: none"> <li>▪ RETURN TO THE PJCASE PERSON, to return to the PJCase Person Screen, or</li> <li>▪ RETURN TO PJ CASE MAIN MENU, to return to the PJCase Main Menu screen.</li> </ul>

### **Income Maintenance Functions**

This section provides specific instructions for functions in PJCase used by IM staff.

#### **Adding a Person to an LBP**

Use the LBP Add Person function to add children and parents to an active LBP when the person was not previously included in the LBP and the child or parent lives with the person who chose the LBP. When the person to be added is a child on a case with two parents and both of them have an active LBP, you must make separate entries to add the child to each parent’s LBP.

If the child or parent is listed on the LBP Display screen of the LBP with a stop reason and stop date, use the LBP Reactivate function to reactivate the LBP for the child or parent.

Before you can use PJCase to add a person to an active LBP, the person:



- Must have a state identification number;
- Must be attached to the ABC case with the LBP (listed on the ABC TD07 screen);
- Cannot be active for FIP (status code “A,” “B,” “C,” or “D”) on any other case;
- Cannot be active in an LBP on any other case.

NOTE: If the person is not attached to the case, make the following entries on the ABC TD03 screen to attach them:

- If the person already has TD03 information in ABC, use an entry reason of “C.” If not, use entry reason “A.”
- Enter or update all applicable demographic information for the person. Enter deprivation and paternity coding only when approving FIP or Medicaid.
- Do not enter a status code for the person unless the person is to be pended or activated for a program.

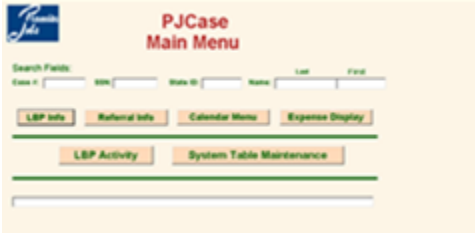
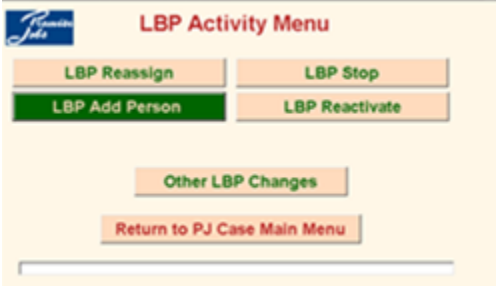
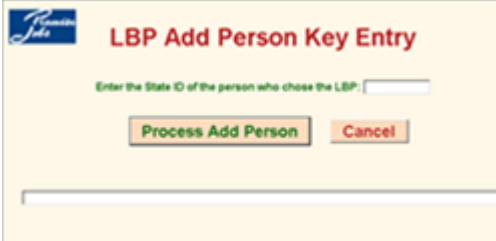
Update and confirm the ABC entries before using the LBP Add Person function to add the person to the LBP.

Step	Action
1	 <p>On the PJCase Main Menu screen, select LBP ACTIVITY to display the LBP Activity Menu screen.</p>
2	 <p>Click on the LBP ADD PERSON button to display the LBP Add Person Key Entry screen.</p>
3	 <p>Enter the state ID of the person who chose the LBP. Select either:</p> <ul style="list-style-type: none"> <li>▪ PROCESS ADD PERSON to display the LBP Add Person screen, or</li> <li>▪ CANCEL to stop your entry.</li> </ul>

Step	Action
4	 <p>The LBP Add Person screen displays information about the LBP and the person who chose the LBP. The bottom of the screen will display each person who is attached to the ABC case who is not included in the LBP.</p> <p>Enter an “X” in the ADD? field next to the person who needs to be added to the LBP. Select either:</p> <ul style="list-style-type: none"> <li>▪ ADD PERSON, to LBP to display the LBP Add Person Confirmation screen, or</li> <li>▪ CANCEL, to stop your entry.</li> </ul>
5	 <p>The bottom of the screen displays each person that you selected to be added to the LBP. Review the information and select either:</p> <ul style="list-style-type: none"> <li>▪ ADD PERSON TO LBP, to complete your entry to add the person to the LBP, or</li> <li>▪ CANCEL, to stop your entry.</li> </ul>

Immediately upon adding a person to the LBP:

- The person’s TD03 screen on ABC will display a FIP individual limit date and LBP data in the LBP field.
- The LBP Display in PJCase for the LBP will include the person.
- ABC will accept entry of the “U” JOBS code for the person if the person is a parent who must also reconsider the LBP.

ABC will assign the “I” FIP status to the person at the next ABC month end processing.

If the person is active for FIP on the day you add the person to the LBP, ABC will recalculate benefits and cancel FIP for the person. ABC sends a *Notice of Decision* to the household the next day.

If the person is not active for FIP and a notice is needed, make the necessary entries in ABC to issue the notice. Use the following case and individual notice reason codes to inform the client that FIP remains canceled or is denied:

- 262 If the LBP is a subsequent LBP within the six-month ineligibility period, **or**
- 268 If the LBP is a first LBP or is a subsequent LBP that is beyond the six-month ineligibility period, **and**
- 861 For each person added to the LBP.

See I4-B(6), [Denying an Application and Canceling Ongoing Benefits: Issuing Another Notice on New Information](#) for more information.



### **Changing an LBP Stop Reason**

The system allows you to change an LBP stop reason if needed. An LBP that is found to be in error needs to be recorded as stopped due to reason code “C,” so that PJCase does not count the LBP as valid when deciding if a future LBP should be a first or a subsequent LBP.

For instance, when the final decision on an appeal reverses an LBP, the LBP Stop Reason needs to be changed from an “A” (stopped pending the appeal) to a “C” (error) to reflect the decision. If this is not done when the final decision is issued, PJCase will not allow PJ to start another LBP if the person later chooses one, as PJCase considers the appeal to still be pending.

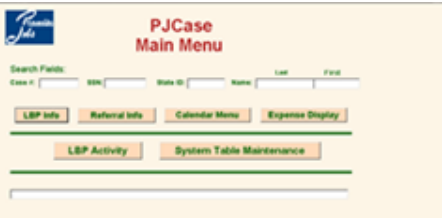
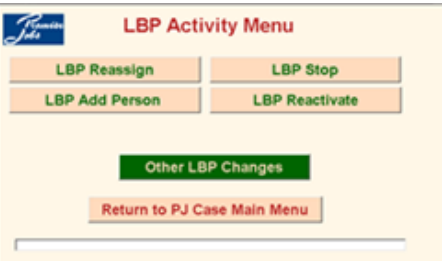
To change an LBP Stop Reason, follow these steps:

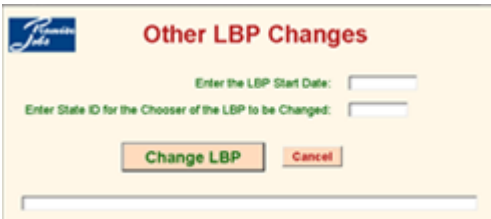
Step	Action
1	 <p>From the PJCase Main Menu, select the LBP ACTIVITY button to display LBP Activity Menu screen.</p>
2	 <p>Click on the OTHER LBP CHANGES button to display the Other LBP Changes screen.</p>

<p>3</p>	 <p>On the Other LBP Changes screen enter the:</p> <ul style="list-style-type: none"> <li>▪ Start date of the LBP to be changed in MM-DD-CCYY format, and</li> <li>▪ State identification of the person who chose the LBP.</li> </ul> <p>Select either:</p> <ul style="list-style-type: none"> <li>▪ CHANGE LBP, to process your entries, or</li> <li>▪ CANCEL, to return to the PJCase Main Menu screen.</li> </ul>
<p>4</p>	 <p>The Other LBP Changes screen now displays the Current LBP Data which includes the:</p> <ul style="list-style-type: none"> <li>▪ Type of LBP,</li> <li>▪ Stop reason, and</li> <li>▪ People on the LBP.</li> </ul> <p>The screen also has a section for New LBP Data, which contains a field called NEW CASE STOP REASON:. This field has a dropdown box with Stop Reason code options for the case. These options are:</p> <ul style="list-style-type: none"> <li>A Appeal</li> <li>C LBP in error</li> <li>E Expired</li> <li>R Cooperated</li> <li>W Stop entire LBP for other reasons</li> <li>Z Administrative stop</li> </ul> <p>NOTE: The New LBP Data section also contains a dropdown box listing the possible LBP types for the new case. Do not choose a new LBP type when changing a Stop Reason.</p> <p>To change a Stop Reason for the case, use the dropdown box to choose the appropriate Stop Reason. Click on the APPLY CHANGES button.</p>



	<p>To change a Stop Reason for a person, enter the appropriate code in the NEW PERSON STOP REASON field next to the person whose Stop Reason you want to change. Click on the APPLY CHANGES button.</p> <p>If you want to stop processing your changes, click on the CANCEL button. You will be returned to the previous screen.</p>
5	<p>Once you have selected APPLY CHANGES, the Other LBP Changes screen will appear with the updated information and a message asking you to review the changes. After reviewing the changes, select either:</p> <ul style="list-style-type: none"> <li>▪ UPDATE LBP, to confirm your changes, or</li> <li>▪ CANCEL, to stop your changes.</li> </ul>

Once you have confirmed the entry, the LBP List and LBP Display screens will show the LBP with the new stop reason.

NOTE: The Other LBP Changes function does not send any notices or cause the ABC system to recalculate benefits. You must make entries in the ABC system to take these actions when needed.

### Correcting an LBP Type

If an LBP type was incorrectly entered in PJCase, follow these steps to correct it:

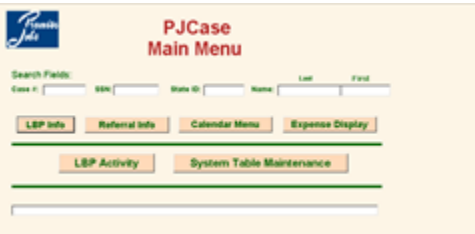
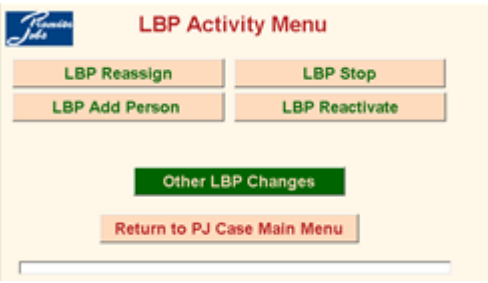
Step	Action
1	 <p>From the PJCase Main Menu, select the LBP ACTIVITY button to display LBP Activity Menu screen.</p>
2	 <p>Click on the OTHER LBP CHANGES button to display the Other LBP Changes screen.</p>

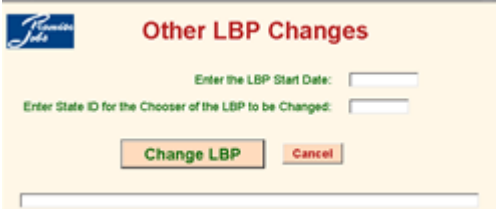
Step	Action
3	
	<p>On the Other LBP Changes screen enter the:</p> <ul style="list-style-type: none"> <li>▪ Start date of the LBP to be changed in MM-DD-CCYY format, and</li> <li>▪ State identification of the person who chose the LBP.</li> </ul> <p>Select either:</p> <ul style="list-style-type: none"> <li>▪ CHANGE LBP button to proceed, or</li> <li>▪ CANCEL to return to the previous screen.</li> </ul>
4	<p>The Other LBP Changes screen now displays the Current LBP Data which includes the:</p> <ul style="list-style-type: none"> <li>▪ Type of LBP,</li> <li>▪ Stop reason, and</li> <li>▪ People on the LBP.</li> </ul> <p>The screen also has a section for New LBP Data, which contains a dropdown box with the available LBP types. The options are:</p> <ul style="list-style-type: none"> <li>▪ Normal: Includes the entire FIP household.</li> <li>▪ Partial: Includes more than one FIP household member but not all.</li> <li>▪ Individual: Includes only the person who chose the LBP.</li> </ul> <p>NOTE: The New LBP Data section also contains a field called NEW CASE STOP REASON: which has a dropdown box. <b>Do not</b> choose a stop reason when changing an LBP type.</p> <p>Choose the appropriate LBP type for the NEW CASE TYPE OF LBP: dropdown box and select either:</p> <ul style="list-style-type: none"> <li>▪ APPLY CHANGES, to update your entry, or</li> <li>▪ CANCEL, to stop the entry and return to the previous page.</li> </ul>
5	<p>Once you have selected APPLY CHANGES, the OTHER LBP CHANGES screen will appear with the updated information and a message asking you to review the changes.</p> <p>After reviewing the changes, select either:</p> <ul style="list-style-type: none"> <li>▪ UPDATE LBP, to confirm your changes, or</li> <li>▪ CANCEL, to stop your changes.</li> </ul>

If an LBP is started with an incorrect LBP type, the LBP may either include people who are not subject to the LBP or may not include people who are subject to the LBP.

The Other LBP Changes function only changes the LBP type. If you need to add a person to the LBP, see [Adding a Person to an LBP](#). For example, if you changed an LBP type from individual to partial or normal, you must add the affected household members to LBP. See [Stopping an LBP](#) if you need to stop the LBP for a person who does not belong in the LBP.

### **Reactivating an LBP**

Use the LBP Reactivate function to reactivate a stopped LBP that still applies to the household. The LBP may be reactivated after being stopped partially or entirely for one of these reasons:

- A parent who chose the LBP left the home but has now returned to the home.
- A child left the home of the parent who chose the LBP but has now returned.
- An appeal was filed but the final decision has affirmed the LBP.

When reactivating a stopped LBP, you can also use the LBP Reactivate function to add people who were not previously included in the LBP.

NOTE: A person who was not previously included in the LBP must be attached to the ABC case before you make PJCase entries to add the person to the LBP. Before you can use PJCase to add a person to an active LBP, the person:

- Must have a state identification number.
- Must be attached to the ABC case with the LBP (listed on the TD07 screen).
- Cannot be active for FIP on any other case (status codes “A,” “B,” “C,” or “D”).
- Cannot be active in an LBP on any other case.

Check the ABC TD07 screen to find who is attached to the case. If the person is not attached to the case, make the following ABC entries on TD03 to attach them:

- If the person’s information is already in the ABC TD03 screen, use entry reason code “C.” If not, use entry reason code “A.”
- Enter or update all applicable demographic information for the person including deprivation and paternity fields if the person is a child.
- Do not enter a status code for the person unless the person is to be pended or activated for a program.

Update and confirm the ABC entries before using the LBP Reactivate function to add the person to the LBP.



When the case has two parents and each has an LBP that needs to be reactivated, you will need to make separate entries to reactivate each parent’s LBP.

### **Reactivating LBP Stopped for Reason A**

When IM reactivates an LBP that has been stopped using reason A – Appeal, the system will apply a new LBP start date.

NOTE: IM workers cannot reactivate an LBP that was stopped due to an appeal with a date before October 27, 2003. If reactivation is required, contact central office through normal channels.

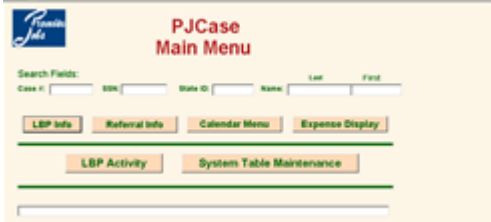
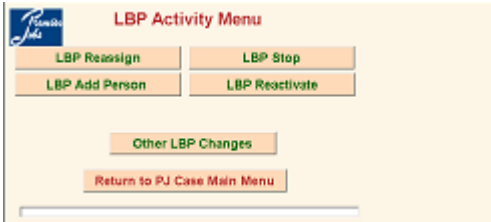
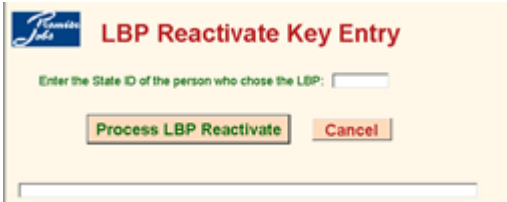
Follow the steps below to reactivate an LBP stopped due to reason code "A."

Step	Action
1	 <p>On the PJCase Main Menu screen, select the LBP ACTIVITY button to display the LBP Activity Menu screen.</p>
2	 <p>Click on the LBP REACTIVATE button. This displays the LBP Reactivate Key Entry screen.</p>
3	 <p>Enter the state identification of the person who chose the LBP and select the PROCESS LBP REACTIVATE button. This displays the LBP Reactivate screen.</p>
4	

Step	Action
	<p>The top of the LBP Reactivate screen displays information about the LBP and the person who chose the LBP.</p> <p>The middle section of the screen contains appeal information.</p> <p>The LBP Reactivate screen displays a System Generated New LBP Start Date and a blank field that allows worker to enter a "User Entered New LBP Start Date." The IM worker may enter a different LBP start date if the system-generated date does not apply.</p> <ul style="list-style-type: none"> <li>▪ The system-generated date applies when timely notice is needed to reactivate the LBP. Timely notice is needed when FIP is active or FIP is canceled effective the same date as the system-generated date.</li> </ul> <p>NOTE: Make no entry in the USER ENTERED NEW LBP START DATE field when the system-generated date applies.</p> <ul style="list-style-type: none"> <li>▪ The user-entered date applies when FIP was reinstated pending the appeal but has been canceled for reasons other than the LBP with an effective date earlier than the system-generated date. A user-entered effective date must be after the date the final decision is issued.</li> </ul> <p>Enter the new effective date in the USER ENTERED NEW LBP START DATE field if applicable.</p>
5	<p>The bottom of the screen displays a list of all people who were originally included in the LBP with "On LBP" in the Located column and an "X" in the REACTIVATED? field. Delete the "X" if the person no longer lives in the home and is no longer affected by the LBP.</p> <p>The list also includes each person currently attached to the case who was not included in the LBP with "On Case" in the Located column (e.g., a child born after the imposition of the original LBP).</p> <p>The REACTIVATE? field will be blank for people who were not originally included in the LBP. Enter an "X" for each person in the home who needs to be added to the LBP.</p> <p>NOTE: The person who chose the LBP is <b>always</b> reactivated, so is never listed at the bottom of the screen.</p> <p>Select either:</p> <ul style="list-style-type: none"> <li>▪ REACTIVATE LBP, to update your entries, or</li> <li>▪ CANCEL, to stop your entries.</li> </ul> <p>Clicking on the REACTIVATE LBP will cause the LBP Reactivate Confirmation screen to appear.</p>

Step	Action
6	 <p>Review the updated information and select either:</p> <ul style="list-style-type: none"> <li>▪ REACTIVATE LBP, if correct, or</li> <li>▪ CANCEL, to stop the entries from updating.</li> </ul>

**Results of Reactivating LBP Stopped for Reason A**

When you reactivate an LBP that was stopped pending an appeal, the following things occur:

- As soon as you confirm your entry:
  - The LBP LIST screen displays the reactivated LBP with a new start date. The original LBP is displayed with Stop Reason code “Z” and the date that you made the reactivation entries as the stop date.
  - The LBP Display screen will display the LBP as active.
  - The ABC TD03 screen of each reactivated person will display:
    - The last month of FIP eligibility in the FIP LIMIT field.
    - The LBP Start Date and either “I” for a first LBP or “Sub” for a subsequent LBP in the LBP field.
  - The LBP Referral Transaction History screen will show that the LBP was reactivated, the date and time of entry, and the worker number of the person who made the entry.
- During ABC processing:
  - The system will generate a *Notice of Decision* to the household using the following case and individual notice reason codes:
    - 257 A first LBP was reactivated with a “new” effective date.
    - 258 A subsequent LBP was reactivated with a “new” effective date.
  - If FIP is active, the system recalculates benefits and cancels FIP for the people reactivated to the LBP.
- At the next ABC month-end processing, ABC assigns the “I” FIP status code to the person affected.

**Reactivating LBP Stopped for Reason Other Than A**

Follow the steps below to reactivate an LBP not stopped due to reason A – Appeal.

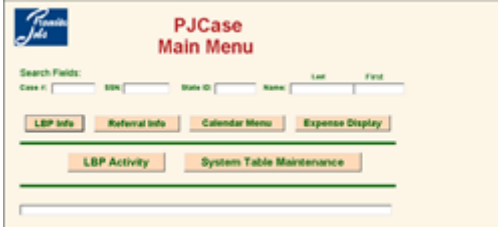
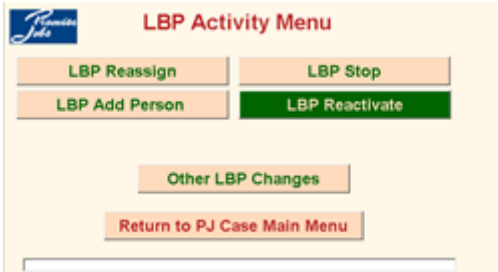
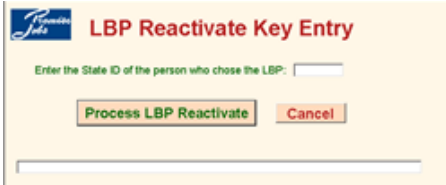
Step	Action
1	 <p>On the PJCase Main Menu screen, select LBP ACTIVITY to display the LBP Activity Menu screen.</p>
2	 <p>Click on the LBP REACTIVATE button. This displays the LBP Reactivate Key Entry screen.</p>
3	 <p>Enter the state identification of the person who chose the LBP and select the PROCESS LBP REACTIVATE button. This displays the LBP Reactivate screen.</p>

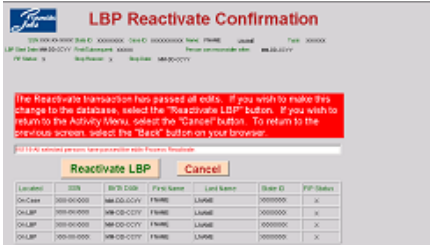
Step	Action
<p>4</p>	 <p>The top of the LBP Reactivate screen displays information about the person who chose the LBP and the actual LBP.</p> <p>The bottom of the screen displays all people who were originally included in the LBP and all other people attached to the case. The REACTIVATE? field will have an “X” for those originally included in the LBP and will be blank for other people attached to the case.</p> <p>Enter an “X” in the REACTIVATE? field for any person who needs to be added to the LBP. Delete the “X” for any person originally included in the LBP who is no longer subject to the LBP.</p> <p>Click on the REACTIVATE LBP button. This displays the LBP Reactivate Confirmation screen.</p>
<p>5</p>	 <p>The LBP Reactivate Confirmation screen displays each person that you selected to be reactivated or added to the LBP. Review the information and if correct, select either:</p> <ul style="list-style-type: none"> <li>▪ REACTIVATE LBP, to confirm your entries, or</li> <li>▪ CANCEL, to stop your entries.</li> </ul>

**Results of Reactivating LBP Not Stopped for Reason A**

When you confirm your entries, the following actions will occur immediately:

- The person’s ABC TD03 screen will display a FIP client’s FIP LIMIT date and LBP data in the LBP field, and
- The LBP Display will list each reactivated and added person with no stop reason code or stop date.



ABC will assign the “I” FIP status code to the person at the next ABC month-end processing. If the person is active for FIP on the day you make the reactivation entry, ABC will recalculate benefits and cancel FIP for the person. ABC sends a *Notice of Decision* to the household the next day.

If the person is not active for FIP and a notice is needed, make an entry in the ABC system to issue the notice. When you have reactivated an LBP that was stopped for reasons other than “A” (appeal), use the following notice reasons to inform the client that FIP remains canceled or is denied:

- 262: For a subsequent LBP within the six-month ineligibility period.
- 268: For a first LBP or a subsequent LBP that is beyond the six-month ineligibility period.
- 861: For each person added to the LBP.

See 14-B(6), [Denying an Application and Canceling Ongoing Benefits: Issuing Another Notice on New Information](#) for more information.

### **Reassigning an LBP to a New Case Number**

IM staff use the LBP Reassign function to assign an active LBP to another case number when:

- The person who chose the LBP moves in with another FIP household and the LBP applies to people in the new home, or
- The active LBP was established on a case that has been dropped from the ABC system before 3/24/06.

The LBP Reassign function also allows IM workers to:

- Add people from the new case to the LBP, and
- Reactivate people originally included in the LBP who are now stopped.

**Important:** PJCase cannot process a stop entry for the person who chose an LBP when the LBP is assigned to a case number that is dropped from the ABC system. PJCase will give you error message 5037 if you make a stop entry in this situation. The LBP must be reassigned to the new case number. You can stop an LBP for a person who is not the chooser even if the case number is no longer on ABC.

The following criteria must be met before PJCase will allow you to assign an LBP to another case:



- FIP must be inactive (a status code other than “A,” “B,” “C,” or “D”) on the current case for each person who is active on the LBP. Check the case in ABC for current FIP status code. When appropriate, cancel FIP on the current case before attempting to reassign the LBP.



- Each person who is active in the LBP must be attached to the ABC case that the LBP will be reassigned to. Check the TD07 screen of the case in ABC to find who is attached to the case. If the person is not attached to the case, make the following entries on TD03 in ABC to attach the person:
  - If the person already has TD03 information in ABC, use an entry reason code of “C.” If not, use entry reason code “A.”
  - Enter or update all applicable demographic information. Enter deprivation and paternity coding if the person is a child and you are approving FIP or Medicaid.
  - Do not enter a FIP status code for the person unless the person is to be pended or activated for the program.

ABC entries to add the person must be updated and confirmed before reassigning the LBP to the new case number.

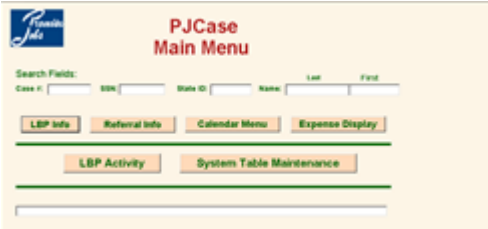
If a person currently included in the LBP no longer lives with the person who chose the LBP, you must first stop the LBP for that person before reassigning the LBP to a new ABC case number. See [Stopping an LBP](#).

Follow these steps to reassign an LBP to a new case number.

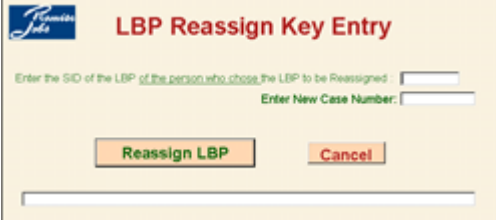
Step	Action
1	 <p>From the PJCase Main Menu, select the LBP ACTIVITY button.</p>
2	 <p>From the LBP Activity Menu, select the LBP REASSIGN button. This displays the LBP Reassign Key Entry screen.</p>

Step	Action
3	 <p>Enter the state identification of the person who chose the LBP and the new case number, and then select either:</p> <ul style="list-style-type: none"> <li>REASSIGN LBP to display the LBP Reassign screen, or</li> <li>CANCEL to return to the previous screen.</li> </ul>
4	 <p>Enter an “X” in the INCLUDE? field to add a person to the LBP or to reactivate the LBP for a person that is stopped.</p>
5	<p>Select either:</p> <ul style="list-style-type: none"> <li>REASSIGN LBP, to display the LBP Reassign Confirmation screen or</li> <li>CANCEL, to return to the previous screen.</li> </ul>
6	 <p>Check the data and if correct, select either:</p> <ul style="list-style-type: none"> <li>COMPLETE LBP REASSIGN, to process your entries, or</li> <li>CANCEL, to keep your entries from updating.</li> </ul>

### **Results of Reassigning an LBP to a New Case Number**

When the LBP Reassign function is complete, the system:

- Records the LBP under the new case number in PJCase.
  - The LBP DISPLAY screen will display the new case number.
  - The LBP Transaction History screen will show that the LBP was reassigned, the date and time it was reassigned, and who reassigned the LBP.
- Changes the individual FIP status code of the people in the LBP as follows:
  - To “N” on the former case when a person’s FIP status code is “I” on the former case. EXCEPTION: The system does not change the status code from “I” to “N” when the person’s FIP notice reason code is 203, 310, 311, 312, 313, 908 or 995, as this indicates that another sanction exists.
  - To “I” on the newly assigned case for people in the LBP when the FIP status code was an “I” on the former case.
- Recalculates benefits and sends a *Notice of Decision* using notice reason codes when FIP is active for anyone now included in the LBP on the newly assigned case:
  - 262 For a subsequent LBP within the six-month ineligibility period.
  - 268 For a first LBP or a subsequent LBP beyond the six-month ineligibility period.
- The ABC’s TD03 screen of each reactivated person will display:
  - The last month of FIP eligibility in the FIP LIMIT field.
  - The LBP start date and either “I” for a first LBP or “Sub” for a subsequent LBP in the LBP field.

### **PROMISE JOBS Functions**

This section provides instructions for the PJCase functions used by PROMISE JOBS staff.

#### **Assigning PJCase Person to PJ Caseworker**

Each person with a social security number who is currently referred to PJ has a PJCase Person screen in PJCase. The PJCase Person screen has a PJ Caseworker section that includes a field for the AGENCY, COUNTY, WORKER ID, WORKER NAME, and PHONE #.

PJCase will assign the PJCase Regional Mailbox to each referred person’s PJCase Person screen as a default PJ caseworker for the purpose of sending informational emails intended for PJ staff.

Once the case is assigned to an ongoing PJ caseworker, the worker updates the PJCase Person screen with the WORKER ID (STDK ID). Use the following steps to update the PJ Caseworker fields:



Step	Action
1	Access the person's PJCase Person screen.
2	 <p>Enter information in the following fields:</p> <ul style="list-style-type: none"> <li>County</li> <li>Worker id (stdk id)</li> </ul> <p>Click the UPDATE PJ WORKER button.</p> <p>The PJCase Person screen will immediately reflect your Agency, County, Worker ID, Worker Name and Phone #. Any PJCase generated emails regarding the referred person will be sent directly to you.</p> <p>The IM worker can use the PJCase Person screen to identify you as the PJ worker working with the referred person.</p>

NOTE: When the IM worker changes the person's county of residence in the ABC system, PJCase will assign the PJ Caseworker fields to the PJCase Regional Mailbox of the newly entered county of residence.

### Changing an Active FIA Date

Follow the steps below to make PJCase entries to change an active FIA date:

Step	Action
1	Access the person's PJCase Person screen.
2	 <p>On the PJCase Person screen, select the FIA MENU button. This will display the FIA Menu screen.</p>

Step	Action
3	 <p>Enter the current FIA date in the ACTIVE FIA DATE field then press the CHANGE ACTIVE FIA DATE button.</p> <p>NOTE: The system does not issue an email to the IM worker when this field is used to update the FIA date. A PJ worker who uses this process to record a new FIA Signed Date because PJCase is already displaying an Active FIA date must send an email to the IM worker notifying the worker that the FIA has been signed.</p>
4	 <p>Select either:</p> <ul style="list-style-type: none"> <li>▪ CHANGE ACTIVE FIA DATE, to update the FIA date, or</li> <li>▪ CANCEL, to return to the FIA Menu screen.</li> </ul>
5	<p>Successful processing of FIA SIGNED entries records the Active FIA Date in the PJCase system.</p>

### **Pre-FIP Entries: Applicant Did Not Choose LBP**

PJ staff use the FIA Menu screen to record a mandatory FIP applicant’s completion or failure in signing an FIA when the applicant has **not** chosen an active LBP. The FIA MENU function is available to only PJ and HHS policy staff.

PJ staff make entries within one working day after the referred person signs or fails to sign the FIA. If the applicant chose an active LBP, use the instructions in [Pre-FIP Entries: Applicant Chose LBP](#).

Use the Pre-FIP function to record the applicant’s completion of or failure to sign an FIA for an applicant in an active LBP who must sign an FIA before FIP approval when the applicant is not the person who chose the LBP. For the person who chose the LBP, refer to [Pre-FIP Entries: Applicant Chose LBP](#) for instructions to record the completion of or failure to sign an FIA.

The FIA Menu screen contains the following fields:

- **STATE ID:** Displays the referred person’s state identification number (SID).
- **CASE ID:** Displays the referred person’s ABC system case number.
- **SSN:** Displays the referred person’s social security number.
- **REFERRAL STATUS:** Displays the person’s referral status. Valid statuses are:
 

Applicant	Person is applying for FIP and current JOBS code is “3.”
Hardship applicant	Person has used 60 months of FIP and is applying for a six-month hardship exemption period. Current JOBS code is “4.”
Applicant with LBP	Person has an active LBP and is applying for FIP. Current JOBS code is “U.”
Hardship applicant w/LBP	Person has an active LBP, has used 60 months of FIP, and is applying for a six-month hardship exemption period. Current JOBS code is “W.”
Participant	Person is receiving FIP, or is a parent receiving for children in the home, and current JOBS code is “8.” (FIP status is “A,” “B,” “C” or status code is “F” or “I” with an “in-home” indicator of “Y.”)
Participant/hardship	Person has used 60 months of FIP and is eligible for a six-month hardship exemption period and current JOBS code is “7.” FIP status is “A,” “B,” “C” or “E,” or status is “F” or “I” with an “in-home” indicator of “Y.”
- **CURRENT JOBS CODE:** Displays the person’s current JOBS referral code as follows:
 

IWD	Description
1	Exempt
3	Mandatory applicant
4	Mandatory, hardship applicant
U	Mandatory applicant w/LBP
W	Mandatory hardship applicant w/LBP
8	Mandatory participant
7	Mandatory participant w/hardship
X	Unknown or not active

- **REFERRAL NAME:** Displays the name of the referred person.
- **DATE OF BIRTH:** Birth date of the referred person.
- **MINOR PARENT?:** Indicates whether the person's minor parent status is coded "4" in the MINOR field on the ABC TD03 screen.
  - Yes      Person's status is "4," indicating that the person is living in a three-generation FIP household.
  - No      Person is not coded "4," indicating the person either:
    - Is not a minor parent, or
    - Is a minor parent but is living independently or with self-supporting parents, a legal guardian, or a nonparental relative or has been married.
- **TWO PARENTS ON FIP?:** Indicates if both parents are on FIP.
  - Yes      Case aid-type is "35-0" on TD01 of ABC.
  - No      Case aid-type is not "35-0."
- **FIP STATUS:** Displays the current FIP status of the referred person.
- **REFERRAL DATE:** Displays the date of the most recent "original" referral or "re-referral."
- **IS THERE AN ACTIVE LBP?:** Indicates whether the person is the chooser of an active LBP.
  - Yes      The person has chosen an active LBP.
  - No      The person did not choose the active LBP. The person is active on another person's LBP, but is not the person who chose the LBP.
- **SERVICING AGENCY:** Identifies the agency providing PJ services.
  - IWD      Iowa Workforce Development
- **ACTIVE FIA DATE:** This field is blank for FIP applicants. The Pre-FIP function is intended to record a FIP applicant's completion of or failure to sign an FIA. Once the applicant's FIA date is entered, the FIA SIGN DATE field will display the date.

If there is a date in this field, PJCase will not allow you to use the Pre-FIP function. Enter the current FIA date in the ACTIVE FIA DATE field of the ACTIVE FIP section. See [Changing an Active FIA Date](#) for more information.

NOTE: There is also an ACTIVE FIA DATE field in the ACTIVE FIP section of this screen.

The FIA MENU screen contains the following sections with their respective fields and action buttons:

- **PRE-FIP:**
  - **FIA SIGNED:** Select to record referred person's signing of an FIA.
  - **FIA NOT SIGNED:** Select to record the referred person's failure to attend an interview or failure to sign a FIA.
  - **FIA SIGN DATE:** Displays the date that the applicant signed an FIA.





- **ACTIVE FIP:**
  - **CHANGE ACTIVE FIA DATE:** Select to record a different FIA date.
  - **ACTIVE FIA DATE:** Used to enter the date the FIA was signed.

The FIA MENU screen also contains these action buttons:

- **REFRESH REFERRAL:** Select to refresh all transactions made on the referral on the current day. See [Refreshing an Entry](#) for more information.
- **RETURN TO PJCASE PERSON:** Select to return to the PJCase Person screen.

### **FIA Signed**



Follow the steps below to make PJCase entries when the FIP applicant has written and signed a FIA:

Step	Action
1	Access the person's PJCase Person screen.
2	 <p>On the PJCase Person screen, select the FIA MENU button. This will display the FIA Menu screen.</p>
3	 <p>Enter the date the FIA was signed by the referred person in the FIA SIGN DATE field and select either:</p> <ul style="list-style-type: none"> <li>▪ FIA SIGNED, to display the FIA Signed Confirmation screen (see Step 4 for screen display), or</li> <li>▪ RETURN TO PJCASE PERSON, to return to the PJCase Person screen without updating your entries.</li> </ul>

	<p>NOTE: The system does not allow entry of a date in this field when:</p> <ul style="list-style-type: none"> <li>▪ The field already contains a date and returns the following error message: Error 6003: Invalid entry. FIA SIGNED DATE already exists.” See <a href="#">Changing an Active FIA Date</a> for information on updating the field with a new date.</li> <li>▪ The applicant has chosen an active LBP and returns the following error message: “Error 6001: Invalid entry. Per JOBS code, active LBP. Access LBP Display instead.” See <a href="#">Pre-FIP Entries: Applicant Chose LBP</a>.</li> <li>▪ The person’s JOBS code is “1” and returns the following error message: “Error 6000: Invalid entry. Per JOBS code, person is not applying for FIP.” Discontinue your entry.</li> </ul>
<p>4</p>	 <p>Select either:</p> <ul style="list-style-type: none"> <li>▪ COMPLETE FIA SIGNED, to update your referral entries, or</li> <li>▪ CANCEL, to return to the FIA Menu screen.</li> </ul>
<p>5</p>	<p>Successful processing of FIA SIGNED entries:</p> <ul style="list-style-type: none"> <li>▪ Sends an email to the IM worker, alerting the IM worker to proceed with the FIP eligibility determination.</li> <li>▪ Records the Active FIA Date in the PJCase system.</li> <li>▪ Changes the “applicant” JOBS code to a valid “participant” code, if the person is pended for FIP, or to the “unknown” status code, if the person is not pended. The IM worker will update the “unknown” code to a valid “participant” code if FIP is approved.</li> </ul>

**FIA Not Signed**

Follow the steps below to make PJCase entries when the FIP applicant has failed to attend an interview or to write and sign a FIA:

Step	Action
1	Access the person's PJCase Person screen.
2	 <p>On the PJCase Person screen, select the FIA MENU button. This will display the FIA Menu screen.</p>
3	 <p>Select either:</p> <ul style="list-style-type: none"> <li>▪ FIA Not Signed, to display the FIA Not Signed Confirmation screen, or</li> <li>▪ Return To PJCase Person, to return to the PJCase Person screen without updating your entries.</li> </ul>
4	 <p>Select either:</p> <ul style="list-style-type: none"> <li>▪ COMPLETE FIA NOT SIGNED, to update your referral entries, or</li> <li>▪ CANCEL, to return to the FIA MENU screen.</li> </ul>

Step	Action
5	<p>When FIA NOT SIGNED entries are successfully processed, PJCase:</p> <ul style="list-style-type: none"> <li>▪ Denies the application in ABC and sends a <i>Notice of Decision</i> when the person is a FIP parent and the IM worker has pended the application in ABC. Otherwise, the IM worker must make ABC entries to deny the FIP application and send the notice.</li> <li>▪ Sends an email to the IM worker to report whether the system denied the application or the IM worker needs to make ABC entries to deny the application.</li> <li>▪ Changes the person’s “applicant” JOBS code to “unknown.”</li> </ul>

### **Pre-FIP Entries: Applicant Chose LBP**

Using the Pre-FIP function is not appropriate for applicants that have chosen an LBP. Instead, access LBP Display to either:

- Stop the LBP when an applicant signs an FIA and, for a subsequent LBP, completes 20 hours of PJ activity. Follow the instructions found at [Functions Used by Both IM and PJ Staff: Stopping an LBP](#).
- Record that the applicant has abandoned the reconsideration attempt using the following steps.

Step	Action
1	Access the LBP Display screen for the active LBP.
2	 <p>Select either:</p> <ul style="list-style-type: none"> <li>▪ ABANDON RECONSIDERATION, to proceed to the Abandon Reconsideration Confirmation screen, or</li> <li>▪ CANCEL, to return to the PJCase Main Menu screen.</li> </ul>

Step	Action
3	 <p>Select either:</p> <ul style="list-style-type: none"> <li>Complete LBP Abandon Reconsideration, to update your entry, or</li> <li>CANCEL, to return to the PJCase Main Menu screen.</li> </ul>
4	<p>When an LBP ABANDON RECONSIDERATION entry is successfully processed, PJCase:</p> <ul style="list-style-type: none"> <li>Denies the application in ABC and sends a <i>Notice of Decision</i> when the person is a FIP parent and the IM worker has pended the application in ABC. Otherwise, the IM worker must make ABC entries to deny the FIP application and send the notice.</li> <li>Sends an email to the IM worker to report if the system denied the application, or if the IM worker needs to make ABC entries to deny the application.</li> <li>Changes the person’s “applicant” JOBS code to “unknown.”</li> </ul>

### Issuing Expense Allowance Payments

PJ workers use the Expense Request screen to issue expense allowance payments to providers and to PROMISE JOBS customers.

For providers that are registered with the Department of Administrative Services for electronic funds transfer, allowance payments are deposited directly and appear on the Issuance Verification (ISSV) system as “DIR DEP.” If electronic funds transfer is not established, the allowance payments are issued by a paper warrant.

For participants who have direct deposit established for their FIP payments, the allowance payments will also be direct deposited and will appear on ISSV as “DIR DEP.” If direct deposit is not established, allowance payments will be issued by a paper warrant.

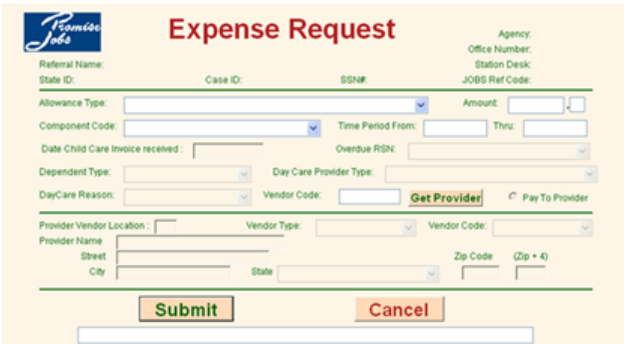

The Expense Request screen contains the following fields:

- **AGENCY:** Displays I as the IWD agency code of the worker who is logged in.  
I IWD
- **OFFICE NUMBER:** Displays the four-digit office number of the worker who is logged in.
- **REFERRAL NAME:** Displays the referred person's name.
- **STATION DESK:** Displays the three- or four-digit worker identification number of the worker who is logged in.
- **STATE ID:** Displays the referred person's state identification number (SID).
- **CASE ID:** Displays the referred person's ABC case number.
- **SSN#:** Displays the referred person's social security number.
- **JOBS REF CODE:** Displays the person's current JOBS referral code as follows:

IWD	Description
I	Exempt
3	Mandatory applicant
4	Mandatory, hardship applicant
U	Mandatory applicant w/LBP
W	Mandatory hardship applicant w/LBP
8	Mandatory participant
7	Mandatory participant w/hardship
X	Unknown or not active
- **ALLOWANCE TYPE:** Use the dropdown list is to choose the applicable expense allowance. The choices are:

A	Transportation, mileage or actual for PJ; one-time costs such as tires, repairs, etc., for FSSG
B	Tools, PJ and FSSG
C	Uniforms and safety equipment for PJ; uniforms and other clothing needs for FSSG
D	Tuition for PJ
E	Books for PJ
F	Education supplies for PJ
G	Fees, education-related, and birth certificate costs, PJ and FSSG
H	Licensing, certification and testing costs, including travel costs, PJ and FSSG
L	Transportation, handicapped, for PJ
M	Practicum living costs for PJ (up to \$10 per day)
N	Shelter for FSSG
P	Provider payment for PJ (for parenting classes and PJ family development only)
R	Relocation for FSSG
S	Social services for FSSG
T	Other for FSSG

- **AMOUNT:** Enter the dollar amount of the expense request in the first section, use the TAB key to move to the second section and enter the amount of cents.
- **COMPONENT CODE:** Displays the applicable component code that allows for payment of expenses with PJ funds. The choices are:
  - AA Orientation
  - AB Assessment
  - BA Job-seeking skills (job readiness)
  - C Group job search
  - E High school completion
  - F GED
  - G Adult basic education
  - H English as a second language
  - L Work experience
  - MH Mental health treatment
  - N Unpaid community service
  - OR Other rehabilitation
  - PE Post-secondary classroom training (educational)
  - PV Post-secondary classroom training (vocational)
  - RA On-the-job training
  - SA Substance abuse treatment
  - TE Institutional skills training (educational)
  - TV Institutional skills training (vocational)
  - VE Short-term training (30 to 52 weeks)
  - VV Short-term training (less than 30 weeks)
  - WE Workplace essentials
  - 10 FSSG
  - 2B Individual job search
  - 6 Child care for employment
  - 7A Parenting classes (for 19 and younger)
  - 7B Parenting classes (for all others)
  - 8A Family development services (for parents aged 17 or younger)
  - 8B Family development services (for all others)
- **TIME PERIOD FROM:** Use these fields to enter the beginning date of the period the allowance covers, in MM-DD-CCYY format.
- **THRU:** Use these fields to enter the ending date of the period the allowance covers, in MM-DD-CCYY format.
- date child care invoice received: Inactive field.
- **OVERDUE RSN:** Inactive field.
- dependent type: Inactive field.
- day care provider type: Inactive field.
- **DAYCARE REASON:** Inactive field.

- **VENDOR CODE:** This field requires entry of the vendor's nine-digit federal tax identification or social security number.
- **GET PROVIDER:** This button is used to obtain provider name and address information when a provider number has been entered. Clicking the GET PROVIDER button enables the PAY PROVIDER button.

If the provider is in the State Accounting payment system, a vendor list will be displayed so the correct location can be selected.

If the provider is not in the State Accounting payment system, PJCase will generate error message 5184, "Vendor not found in the I/3 payment system. Contact your local PJ designee for assistance."

- **PAY TO PROVIDER:** This field allows you to indicate when the expense allowance payment is to be paid to the service provider rather than the PROMISE JOBS participant. This field must be completed when the allowance type is "P." To enable this button, enter the provider number and click on the GET PROVIDER button.
- **PROVIDER VENDOR LOCATION:** This field displays the two-digit identifier for the provider vendor location. The system populates this field when the vendor is selected from the vendor list.
- **VENDOR TYPE:** Use the dropdown list to select a vendor type when the PAY TO PROVIDER button is selected. The vendor types are:

C	Corporation
G	Government or nonprofit
P	Partnership
S	Sole proprietor
U	Public service
I	Individual



- **VENDOR CODE:** Select the applicable code when the PAY TO PROVIDER button is selected:



E	Employer identification number
S	Social security number
- **PROVIDER NAME:** The system populates this field when the vendor is selected from the vendor list. Worker entry in this field is not allowed.
- **STREET:** The system populates this field when the vendor is selected from the vendor list. Worker entry in this field is not allowed.
- **CITY:** The system populates this field when the vendor is selected from the vendor list. Worker entry in this field is not allowed.
- **STATE:** The system populates this field when the vendor is selected from the vendor list. Worker entry in this field is not allowed.
- **ZIP CODE:** The system populates this field when the vendor is selected from the vendor list. Worker entry in this field is not allowed.
- **(ZIP + 4):** The system populates this field when the vendor is selected from the vendor list. Worker entry in this field is not allowed.

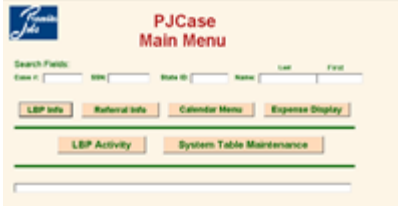

### **Issuing Payment to a Participant**

Follow these steps to issue an expense allowance payment in PJCase:

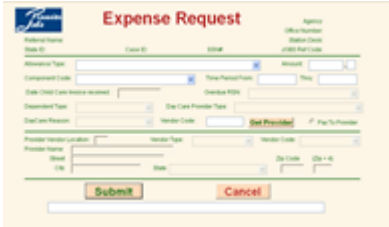

Step	Action
1	 <p>On the PJCase Main Menu screen, enter the person’s case number, SSN, state identification, or name in the applicable search field. Select REFERRAL INFO to display the PJCase Person List screen.</p> <p>NOTE: If there is only one person referred on the case, you will go directly to that person’s PJCase Person screen. Go to Step 3.</p>
2	 <p>Enter an “X” in the DISPLAY? field next the appropriate person and click on the DISPLAY REFERRAL button. This displays the PJCase Person screen.</p>
3	 <p>Click on the EXPENSES button to display the Expense Request screen.</p>

Step	Action
<p>4</p>	 <p>Complete the following fields:</p> <ul style="list-style-type: none"> <li>▪ Allowance Type:</li> <li>▪ Amount:</li> <li>▪ Component Code:</li> <li>▪ Time Period From:</li> <li>▪ Thru:</li> </ul> <p>If the payment is to be sent to the service provider, see <a href="#">Issuing Payment Directly to a Provider</a>.</p> <p>Click on the SUBMIT button.</p> <p>If you receive error message 5160, “Person not on FIP. Submit pends for CO review or Cancel stops the entry,” see <a href="#">Payment Pended for PJ QA Review</a>. If not, continue to Step 5.</p>
<p>5</p>	 <p>On the Expense Confirm screen, verify that the data is correct and select either:</p> <ul style="list-style-type: none"> <li>▪ ACCEPT, to process the entry and display the Expense Accepted screen, or</li> <li>▪ CANCEL, to return to the Referral screen.</li> </ul>

Step	Action
6	 <p>On the Expense Accepted screen, select:</p> <ul style="list-style-type: none"> <li>▪ EXPENSE REQUEST, to make entry to issue another expense allowance,</li> <li>▪ EXPENSE LIST, to view all pending expense allowance entries for the person,</li> <li>▪ REFERRAL, to return to the person’s PJCase Person screen, or</li> <li>▪ MAIN MENU, to return to the PJCase Main Menu screen.</li> </ul>

**Issuing Payment Directly to a Provider**

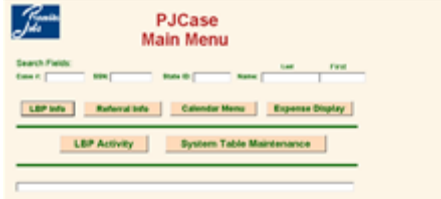
Follow these steps to issue an expense allowance payment directly to a provider in PJCase:

Step	Action																								
1	 <p>On the PJCase Main Menu screen, enter the person’s case number, social security number, state identification number, or name in the applicable SEARCH field. Select REFERRAL INFO to display the PJCase Person List screen.</p> <p>NOTE: If there is only one person referred on the case, you will go directly to that person’s PJCase Person screen. Go to Step 3.</p>																								
2	 <p>The following Referred Persons have been located:</p> <table border="1" data-bbox="459 1629 805 1671"> <thead> <tr> <th>Person #</th> <th>Name</th> <th>State</th> <th>SSN</th> <th>DOB</th> <th>Referral Date (Y-M-D)</th> <th>Referral Status</th> <th>Referral Type</th> </tr> </thead> <tbody> <tr> <td>111111</td> <td>ANDERSON</td> <td>IA</td> <td>123456789</td> <td>01/01/1980</td> <td>06/15/2023</td> <td>ACTIVE</td> <td>REFERRAL</td> </tr> <tr> <td>222222</td> <td>ANDERSON</td> <td>IA</td> <td>123456789</td> <td>01/01/1980</td> <td>06/15/2023</td> <td>ACTIVE</td> <td>REFERRAL</td> </tr> </tbody> </table> <p>To display the PJCase Person screen, enter an “X” in the DISPLAY? field next the person’s name and click on the DISPLAY REFERRAL button.</p>	Person #	Name	State	SSN	DOB	Referral Date (Y-M-D)	Referral Status	Referral Type	111111	ANDERSON	IA	123456789	01/01/1980	06/15/2023	ACTIVE	REFERRAL	222222	ANDERSON	IA	123456789	01/01/1980	06/15/2023	ACTIVE	REFERRAL
Person #	Name	State	SSN	DOB	Referral Date (Y-M-D)	Referral Status	Referral Type																		
111111	ANDERSON	IA	123456789	01/01/1980	06/15/2023	ACTIVE	REFERRAL																		
222222	ANDERSON	IA	123456789	01/01/1980	06/15/2023	ACTIVE	REFERRAL																		

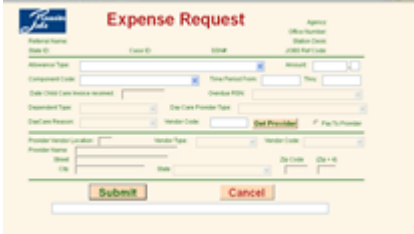
Step	Action
3	 <p>Click on the EXPENSES button to display the Expense Request screen.</p>
4	 <p>Complete the following fields:</p> <ul style="list-style-type: none"> <li>▪ Allowance Type:</li> <li>▪ Amount:</li> <li>▪ Component Code:</li> <li>▪ Time Period From:</li> <li>▪ Thru:</li> <li>▪ Vendor Code:</li> </ul> <p>Select GET PROVIDER button.</p>
5	<p>For new providers not in the State Accounting payment system, PJCase will display error message 5184, “Vendor not found in I/3. Contact your local PJ designee for assistance.”</p> <p>For providers in the State Accounting payment system, continue to step 6.</p>

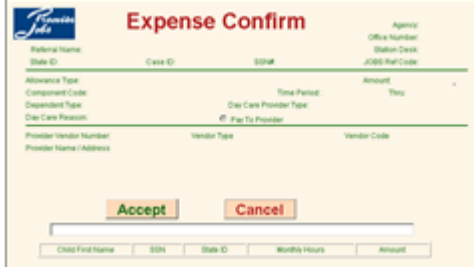
Step	Action																												
<p>6</p>	<p>If the provider is in the State Accounting system, PJCase will display the Vendor List screen. Provider addresses can be either two or three lines.</p>  <p>The following addresses have been located:</p> <table border="1" data-bbox="451 583 816 741"> <thead> <tr> <th>State</th> <th>Location</th> <th>Address</th> <th>City</th> <th>State</th> <th>Zip Code</th> <th>Phone Number</th> </tr> </thead> <tbody> <tr> <td>IA</td> <td>01</td> <td>HAPPY TIME DAY CARE AND QUALITY CARE CENTER 123 MAIN ST</td> <td>JANESVILLE</td> <td>IA</td> <td>52231</td> <td>563-555-5555</td> </tr> <tr> <td>IA</td> <td>01</td> <td>HAPPY TIME DAY CARE AND QUALITY CARE CENTER 456 PLEASANT ST</td> <td>WEST DES MOINES</td> <td>IA</td> <td>50319</td> <td>563-555-5555</td> </tr> <tr> <td>IA</td> <td>01</td> <td>HAPPY TIME DAY CARE AND QUALITY CARE CENTER 789 GARDEN ST</td> <td>EAST DES MOINES</td> <td>IA</td> <td>50319</td> <td>563-555-5555</td> </tr> </tbody> </table> <p>Scroll through the vendor list addresses.</p> <p>If the address on the claim does not match an address on the vendor list screen, do not proceed with issuing the payment. Contact your local PJ designee for further assistance.</p> <p>If the address on the claim matches an address on the vendor list screen, select the correct vendor location by clicking on the select link.</p> <p>You will return to the Expense Request screen with the vendor information fields completed.</p> <p>Click on the SUBMIT button.</p> <p>If your entry is successful, the system displays the Expense Confirm screen.</p> <p>If your entry is not successful, the system displays an error message.</p> <p>If you receive error message 5160, “Person not on FIP. Submit pends for CO review or Cancel stops the entry,” see <a href="#">Payment Pended for PJ QA Review</a>.</p> <p>If not, continue to Step 7.</p>	State	Location	Address	City	State	Zip Code	Phone Number	IA	01	HAPPY TIME DAY CARE AND QUALITY CARE CENTER 123 MAIN ST	JANESVILLE	IA	52231	563-555-5555	IA	01	HAPPY TIME DAY CARE AND QUALITY CARE CENTER 456 PLEASANT ST	WEST DES MOINES	IA	50319	563-555-5555	IA	01	HAPPY TIME DAY CARE AND QUALITY CARE CENTER 789 GARDEN ST	EAST DES MOINES	IA	50319	563-555-5555
State	Location	Address	City	State	Zip Code	Phone Number																							
IA	01	HAPPY TIME DAY CARE AND QUALITY CARE CENTER 123 MAIN ST	JANESVILLE	IA	52231	563-555-5555																							
IA	01	HAPPY TIME DAY CARE AND QUALITY CARE CENTER 456 PLEASANT ST	WEST DES MOINES	IA	50319	563-555-5555																							
IA	01	HAPPY TIME DAY CARE AND QUALITY CARE CENTER 789 GARDEN ST	EAST DES MOINES	IA	50319	563-555-5555																							
<p>7</p>	 <p>On the Expense Confirm screen, verify that the data is correct and select either:</p> <ul style="list-style-type: none"> <li>ACCEPT, to process the entry and display the Expense Accepted screen, or</li> <li>CANCEL, to return to the Referral screen.</li> </ul>																												

Step	Action
8	 <p>On the Expense Accepted screen, select:</p> <ul style="list-style-type: none"> <li>▪ EXPENSE REQUEST, to make entry to issue another expense allowance,</li> <li>▪ EXPENSE LIST, to view all pending expense allowance entries for the person,</li> <li>▪ REFERRAL, to return to the person’s PJCase Person screen, or</li> <li>▪ MAIN MENU, to return to the PJCase Main Menu screen.</li> </ul>

**Payment Pended for PJ QA Review**

Error message 5160 occurs when coding in the ABC system indicates that the person that you are making the payment for is not eligible for FIP or PROMISE JOBS. Specifically, the error occurs when:

- The current FIP status code is “canceled” or “denied,” and the Time Period From date entered is after the effective date of cancellation or denial.
- The payment is not for child care, current FIP status is “canceled” or “denied,” and the effective date of cancellation or denial was two months ago or longer.
- The person is in an active first LBP or an active subsequent LBP that is beyond the six-month period, but the person does not have a JOBS code of “U” or “W.”
- The person is in an active subsequent LBP and the Time Period From date entered is within the six-month period of ineligibility.

Error message 5160 states, “Person not on FIP. Submit pends for CO review or Cancel stops the entry.” Review the case situation of the person when you get error message 5160. If needed, contact the IM worker for assistance.

If you believe that the payment needs to be made even though ABC indicates the person is not eligible, click on the SUBMIT button. Also send an email to

PJ QA staff asking that the case situation be reviewed to determine if the payment should be approved and released.

If PJ QA staff approves the payment, the system sends an email to the PROMISE JOBS worker who made the entry. If PJ QA staff cannot approve the payment, they will respond to the person who asked that the payment be released.

From March through May, a PJ participant attends a short-term training of less than 30 weeks while receiving FIP. FIP is canceled effective May 31. In August, PJ receives the tuition bill from the training facility and makes entry to issue payment to the facility.

The system does not allow the entries to update because FIP has been canceled for more than two months. The worker receives error message 5160 and determines that the payment should be made since the payment is for a period when the person was on FIP.

The worker clicks on the SUBMIT button and sends an email to PJ QA staff. PJ QA staff will review the case and approve the payment, if appropriate.

**Changing or Canceling an Expense Allowance Entry**

PJ workers who have “confirmed” an expense allowance entry can delete or change the entry **on the same day** by following these steps:

Step	Action
1	Access the person’s PJCase Person screen.
2	 <p>Select the EXPENSES button. The system displays the Expenses Entered Not Yet Processed screen.</p>
3	<p>Select either:</p> <ul style="list-style-type: none"> <li>▪ EDIT FROM LIST, to make changes to an allowance entry, or</li> <li>▪ DELETE FROM LIST, to delete the entry entirely.</li> </ul>

**Viewing Expenses Entered and Not Yet Processed**

PJCase allows you to view expense allowances that have been entered for a referred person in the current day. The list also includes any expense allowances made on a prior day and pending for central office review.

Access the Expenses Entered Not Yet Processed screen by clicking on the EXPENSE LIST button in the Expense Accepted screen.

Agency: 1 - MD  
Office Number: 1111  
Station Desk: RM09  
JOBS Ref Code: 8

Referral Name: BUSTER BROWN  
State ID: 3635353F Case ID: P000001102 SSN#: 676336767

**Edit From List** **Delete From List** **Approve Pended**  
**Create New** **Go To Main Menu**

(Select Only One)

Select	Pended Flag	Date Entered	Allowance Type	Component/Education	From Date	To Date	Amount
<input type="checkbox"/>		12-29-2005	J	P E	11-01-2005	11-01-2005	130.00

The Expenses Entered Not Yet Processed screen identifies the referred person and displays:

- Specific data on each expense allowance entry made for the referred person on the day, and
- Specific data on any expense allowance entry made for the referred person on a previous day and pended for central office review but not yet approved.

The screen also contains the following links:

- **EDIT FROM LIST:** Use this option to make changes to a listed expense allowance that has been confirmed but has not processed yet.
- **DELETE FROM LIST:** Use this option to delete a listed expense allowance that has been confirmed but has not processed yet.
- **CREATE NEW:** Use this option to make another expense allowance on the same referred person.

## **Reactivating an LBP**

PJ staff cannot reactivate an LBP. If reactivation of an LBP is required, contact the local IM worker.

## **Starting an LBP**

PJ staff use the LBP Start function to impose an LBP. This function is available only to PJ and HHS policy staff.

When more than one person in a household chooses an LBP, make separate entries to start each person's LBP by accessing the start entry screens from the PJCase Person screen of each person who chose an LBP. See [When More Than One Household Member Chooses an LBP](#) for more information.

You will use two main screens to start an LBP:

- LBP Start Key Entry screen
- LBP – Start screen



### **LBP Start Key Entry Screen**

The screenshot shows the 'LBP Start Key Entry' screen. At the top left is the 'Promise Jobs' logo. The title 'LBP Start Key Entry' is centered at the top. Below the title, the following information is displayed: 'Chooser Name: BUSTER BROWN', 'Chooser SSN: 676-33-6767', 'Chooser State ID: 3535353F', and 'Case #: P000001102'. Underneath, there are radio buttons for 'LBP Type' with options: Normal, Partial, and Individual. To the right is an 'LBP Choice Date' field. A pink highlighted box contains the instruction: 'Enter the other parent's Social Security Number when two parents are in the home with a common child on FIP:'. At the bottom are two buttons: 'Start LBP' and 'Cancel'.

This is the first screen used to start an LBP. The screen contains the following fields.

- **CHOOSE NAME:** Displays the name of the person who chose the LBP.
- **CHOOSE SSN:** Displays the social security number of the person who chose the LBP.
- **CHOOSE STATE ID:** Displays the state identification of the person who chose the LBP.
- **CASE NUMBER:** Displays the ABC case number of the person who chose the LBP.
- **LBP TYPE:** This field allows you to choose one of the following LBP types by clicking in the circle next to the type name:

- Normal. Select normal when the person who chose the LBP is:
  - The parent in a one-parent household, or
  - Either parent in a two-parent household when there is at least one common child on FIP.

NOTE: If a normal LBP is selected on a FIP case in the 30-4 aid type case, the system generates error message 5062, “For caretaker or minor use INDIVIDUAL LBP. For minor parent use PARTIAL LBP.”

NOTE: The system generates error message 5025, “Invalid LBP type. Enter individual LBP type when child with no children chooses,” when a normal LBP type is selected on a person who is under age 18 and is not coded as a minor parent in ABC.

If you attempt to start a normal LBP on a minor parent who receives FIP with the minor’s adult parent, you will receive this error as partial if the correct LBP type and the minor parent is not coded correctly in ABC. Contact the IM worker to enter the MINOR code in the minor parent’s TD03 screen. Once the MINOR code is updated in ABC, you can start the “partial” LBP.

- Partial. Select partial when the person who chose the LBP is:
  - A minor parent receiving FIP with the minor’s adult parent or relative, or
  - A parent in a household that contains two married parents with no common child on FIP.

NOTE: The system generates error message 5025, "Invalid LBP type. Enter individual LBP type when child with no children chooses," when a partial LBP type is selected on a person who is under age 18 and not coded as a minor parent in ABC.

If you receive this error when attempting to start a partial LBP on a minor parent who receives FIP with the minor's adult parent, contact the IM worker to enter the MINOR code in the minor parent's TD03 screen. Once the MINOR code is updated in ABC, you can start the partial LBP.

- Individual. Select individual when the person who chose the LBP is:
  - A child who is not a parent and not attending school full time, or
  - An incapacitated stepparent, or
  - A needy relative who is not a parent of the child.

Contact the IM worker if you need help determining the relationship of people in the household.

- **LBP CHOICE DATE:** Enter the date that the person chose the LBP, in MM-DD-CCYY format. The choice date is the date that the PROMISE JOBS worker submits the case for local or state-level review.

When making entry to start an LBP on a person who is active on an LBP chosen by another person in the home, the choice date entered must be a date that is before the effective date of the existing LBP and before the date of FIP cancellation.

- **ENTER THE OTHER PARENT'S SOCIAL SECURITY NUMBER WHEN TWO PARENTS ARE IN THE HOME WITH A COMMON CHILD ON FIP:** Entry is required in this field on two-parent cases.

Enter the other parent's social security number, regardless of aid type, even if the other parent in the home is not on the FIP grant or is currently exempt from PJ.

Entry of the other parent's social security number allows the system to search for any previous LBPs chosen by the other parent in the home and to decide correctly if the LBP to be started is a first or a subsequent LBP.

Use PJCase and the ABC case aid type to help decide when you need to enter the other parent's social security number:

- ABC case aid-type 35-0 applies when:
  - Two parents are in the home, and
  - Both parents are on FIP, and
  - Both parents are mandatory PJ referrals, and
  - There is a common child on FIP.

When the case aid type is 35-0, PJCase assumes the case is a two-parent home and displays "yes" in the TWO PARENTS ON FIP field on the PJCase Person screen. The system requires entry of the other parent's social security number in the LBP Start Key Entry screen to start an LBP when the field displays "yes." (If needed, select the BACK button on your browser to view the PJCase Person screen.)

- ABC case aid-type 30-0 applies when:
  - Only one parent is in the home, or
  - There are two parents in the home, and
    - One parent is **not** on FIP, or
    - One parent is **not** a mandatory PJ referral, or
    - There is **no common child** on FIP.

Enter the other parent’s social security number when aid type is one of these aid types and there is a common child on FIP.

Do not enter the other parent’s social security number when there are two parents in the home and there are no common children on FIP, (e.g., a case with two stepparents and children of each parent, or a case with a common child who is receiving SSI and is not on FIP). Enter a partial LBP type in this situation.

Do not enter the social security number of a minor parent when starting an LBP on the minor’s adult parent in a three-generation FIP household.

Contact the IM worker if you cannot determine if there is a common child in the home. Also contact the local IM worker to correct the aid type if you find that the household’s living situation is not being reflected with the current aid type in ABC.

**LBP - Start Screen**

The screenshot shows the 'LBP - Start' screen with the following elements:

- Header:** 'Promise Jobs' logo and 'LBP - Start' title.
- Input Fields:** SSN, State ID, Case #, Name, LBP Start Date, First/Subsequent, Person Can Reconsider After, LBP Choice Date, LBP Type, FIP Status.
- FIA Signed?:** Radio buttons for 'Yes' and 'No' (with 'No' selected).
- Additional Chooser Information:** Fields for Existing Name, Existing SSN, Existing Type, Existing State ID, Existing Start Date, Existing First/Sub.
- Kind of Failure:** A dropdown menu.
- Buttons:** 'Start LBP' (green) and 'Cancel' (orange).
- Table:** A table with columns: 'Include?', 'Soc Sec No', 'State ID', 'Name', 'Birth Date', 'FIP Date'. It contains two rows with empty cells.

The LBP Start screen displays after you have made a successful entry in the LBP Start Key Entry screen. This screen contains the following fields:

- **SSN:** Displays the social security number of the person who chose the LBP.
- **STATE ID:** Displays the state identification number of the person who chose the LBP.
- **CASE #:** Displays the ABC case number of the person who chose the LBP.
- **NAME:** Displays the name of the person who chose the LBP.
- **LBP START DATE:** Displays the system-determined effective date of the LBP to be started.
- **FIRST/SUBSEQUENT:** System-determined entry that indicates whether the LBP to be started is a first or a subsequent LBP.
- **PERSON CAN RECONSIDER AFTER:** System-determined entry. If the LBP to be started is a subsequent LBP, this field displays the last day of the six-month period of ineligibility. The household can begin action to reconsider the subsequent LBP at any time **after** this date. If the LBP to be started is a first LBP, this field is blank.
- **LBP CHOICE DATE:** Displays the date that the person chose the LBP. The worker enters this date in the LBP Start Key Entry screen.
- **LBP TYPE:** Displays the LBP type that the worker entered on the LBP START KEY ENTRY screen.
- **FIP STATUS:** Displays the current FIP status of the person who chose the LBP.
- **ADDITIONAL CHOOSER INFORMATION:** This field displays only when the person whose LBP is currently being started is active on another LBP on the case. The field displays the following information regarding the existing LBP:
  - **EXISTING NAME:** Displays the name of the person who chose the LBP.
  - **EXISTING SSN:** Displays that person's social security number.
  - **EXISTING TYPE:** Displays the LBP type (normal, partial or individual).
  - **EXISTING STATE ID:** Displays that person's state identification.
  - **EXISTING START DATE:** Displays the effective date of the existing LBP.
  - **EXISTING FIRST/SUB:** Tells whether the existing LBP is a first or subsequent LBP.
- **FIA SIGNED?:** Indicates if the person had a signed FIA when choosing the LBP. The system uses the ACTIVE FIA DATE (from the person's PJCase Person screen) to populate this field:

Yes	There is a date in the ACTIVE FIA DATE field, or
No	There is no date in the ACTIVE FIA DATE field
- **KIND OF FAILURE:** Entry required. Use the dropdown list to select the reason that describes how the person chose the LBP. The reasons are:

A	Did not make appointment
B	Did not keep appointment
C	Did not complete orientation
D	Did not complete assessment
E	Did not sign FIA
F	Abandoned the FIA
G	Did not verify work hours

- H Did not renegotiate an FIA after previous FIA ended
- I Did not participate in FIA progress review
- K Did not verify hours of participation in activities other than work

If the **FIA SIGNED?:** field is “No,” the KIND OF FAILURE field must be “A,” “B,” “C,” “D,” or “E.”

If the **FIA SIGNED?:** field is “Yes,” the KIND OF FAILURE field must be “F,” “G,” “H,” “I,” or “K.”

- **INCLUDE?:** This field applies only to partial LBPs. Select the people that must be included in the partial LBP as follows:
  - Children of the person who chose the LBP.
  - If the person who chose the LBP is a minor parent on FIP with the minor’s adult parent, and the other parent of the minor parent’s children is in the home, select the other parent.

### **Steps to Start an LBP**

When FIP is active on a case, PJCase will not accept an LBP start entry made on any day that is after the current month’s ABC system timely notice day and up through the current month’s ABC cutoff day. If you try to start an LBP in this period, PJCase will give you an error message at the LBP Confirmation screen and indicate the day that you can retry the start entry.

PJCase will not accept an LBP start entry when the LBP start date will be the same as an existing LBP record chosen by the same person, even if the existing LBP has been stopped.

If you try to start an LBP in this situation, PJCase will give you the following error message: “5304: An LBP exists with the same start date. See your manual.” If you receive this error, determine which of the following applies:

- Your entry to start a new LBP is not needed if the existing LBP is active. Stop attempts to start another LBP.
- If the existing LBP is stopped and the person has chosen another LBP with a new failure, make the LBP start entry after the next timely notice day. As a result, the LBP start date for the new LBP will be at least one month later than the existing LBP.



Ms. A chooses a first LBP for failure to attend an FIA activity twice after receiving a written reminder. On April 22, PJ starts the LBP effective June 1. Ms. A reconsiders the first LBP by signing an FIA on April 24. Ms. A is scheduled to attend the same FIA activity again on May 4.



Ms. A fails to attend and is sent a written reminder. She is scheduled to attend the same activity again on May 11 and chooses a subsequent LBP. PJ must wait until after May timely notice to start the new LBP. The LBP will be effective no earlier than July 1.

- Contact the IM worker to reactivate the existing LBP when the LBP is stopped and should be active, such as when the LBP was affirmed by the final decision of an appeal or the LBP was incorrectly stopped.

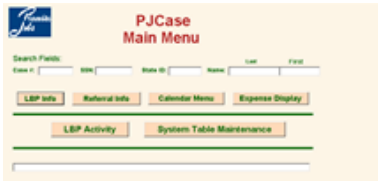
- **Do not** contact IM to reactivate the existing LBP when the existing LBP was stopped appropriately and the person has chosen another LBP (with a new LBP choice date and a new failure.)

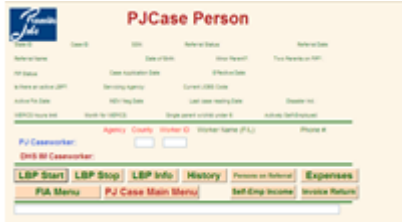
Follow these steps to start an LBP:

Step	Action
1	 <p>On the PJCase Main Menu screen, enter the person’s case number, social security number, state identification number, or name in the applicable SEARCH field. Select REFERRAL INFO.</p> <p>If there is more than one referred person on the case, the PJCase Person List screen will be displayed. Go to Step 2.</p> <p>If there is only one referred person on the case, the PJCase Person screen will be displayed. Go to Step 3.</p> <p>NOTE: When you need to start an LBP for more than one person in a household, make separate entries for each person. See <a href="#">When More Than One Household Member Chooses an LBP</a> section.</p> <p>NOTE: When you are starting an individual or partial LBP on a case with an existing active partial LBP, and the person who chose the new individual or partial LBP is included on the existing partial LBP, contact PJ QA for assistance.</p>
2	 <p>On the PJCase Person List screen, enter “X” in the DISPLAY? Field in the row containing the person’s information. Click on the DISPLAY REFERRAL button to display the PJCase Person screen.</p>
3	 <p>On the PJCase Person screen, select LBP START TO DISPLAY the LBP Start Key Entry screen.</p>

Step	Action
<p>4</p>	 <p>On the LBP Start Key Entry screen:</p> <ul style="list-style-type: none"> <li>▪ Select the applicable LBP type. (Contact the IM worker if you are unsure of the correct type.)</li> <li>▪ Enter the LBP CHOICE DATE:</li> <li>▪ If there is another parent in the home, enter the other parent’s social security number.</li> </ul> <p>Select the START LBP button. (See <a href="#">LBP Start Key Entry Screen</a> for more information on these entries.)</p>
<p>5</p>	 <p>In the LBP START screen:</p> <ul style="list-style-type: none"> <li>▪ Review the “Yes” and “No” boxes in the FIA SIGNED? Field. If the box that is populated does not reflect the current FIA status, delete the “X” and re-enter “X” in the correct field.</li> <li>▪ Use the dropdown box in the KIND OF FAILURE: field to select the reason the LBP is being started.</li> </ul> <p>(See <a href="#">LBP – Start Screen</a> for more information on these entries.)</p> <p>Select either:</p> <ul style="list-style-type: none"> <li>▪ START LBP to display the LBP Start Confirmation screen, or</li> <li>▪ CANCEL to return to the PJCase Person screen.</li> </ul>

Step	Action
6	 <p>In the LBP Start Confirmation screen, check the data. If it is correct, select the COMPLETE LBP START button to process your entry.</p> <p>If the data is incorrect, select either:</p> <ul style="list-style-type: none"> <li>▪ The BACK button on your browser to return to the LBP-Start screen and make corrections, or</li> <li>▪ CANCEL to stop your entries from processing and return to the PJCase Person screen.</li> </ul>

NOTE: When the system processes a start entry for a normal LBP on a case with a child or minor parent who has an active individual or partial LBP, the system will include the child or minor parent in the normal LBP.

However, the system will display the people in the partial or individual LBP with stop season code “I” and the current date for a stop date. This also occurs when the partial or individual LBP is started first and then the normal LBP is started.

### **Results of Starting an LBP**

When an LBP start entry is confirmed in the LBP Start Confirmation screen, the following immediately occurs:

- The LBP Display screen displays the active LBP.
- The system sends an email to the IM worker for the case.
- The ABC system displays the following LBP data for each person in the person’s TD03 screen:
  - The last month of FIP eligibility is displayed in the FIP LIMIT field.
  - The LBP field displays the LBP Start Date and “I” for a first LBP and “Sub” for a subsequent LBP.
- The start transaction is recorded in the LBP Transaction History screen.



When an LBP start entry is confirmed on an active FIP case, the ABC system recalculates FIP benefits as follows:

- For a normal LBP, FIP will be canceled.
- For a partial or individual LBP, the FIP benefits will change. The benefits will be canceled if the people in the partial or individual LBP were the only ones in the household on FIP before the LBP was imposed.
- The system issues a *Notice of Decision* to the household on the next working day.  
EXCEPTION: When both parents in a two-parent household choose a normal LBP, the system does not send an additional *Notice of Decision* when the second LBP is processed.

In the ABC system, the appropriate FIP status code for a person in an active LBP is “I.” When an LBP is started in the PJCase system, the “I” FIP status code will be assigned at the next ABC system cutoff day.

During the nightly system processing that occurs on ABC cutoff day, the system will assign the “I” FIP status code to each person in an active LBP, regardless of the person’s FIP status code on this day. This gives the IM worker some flexibility to continue to make needed adjustments to FIP benefits for the months before the LBP effective date.

#### **When More Than One Household Member Chooses an LBP**

When more than one person in a household chooses an LBP, make separate entries to start each person’s LBP by accessing the LBP start entry screens from the PJCase Person screen for each person. The entry to start each person’s LBP can be made in the same day.

When making entries to start an LBP on a person who is active on an LBP that was chosen by another person in the home, the entered choice date must be a date that is before the effective date of the existing LBP, which is also the effective date of FIP cancellation.

When two parents are in the home and both choose a normal LBP, the system creates the transaction that will send a *Notice of Decision* when processing the LBP that is entered first. When the second parent’s LBP is started, another *Notice of Decision* is not needed and is not sent.

For this reason, the start function will accept the PROMISE JOBS worker’s entry to start the second parent’s entry at any time, even after the effective date of the LBP, so long as the second parent’s choice date is before the effective date of active LBP.

Mr. and Mrs. A receive FIP for their two children. On October 3, both choose an LBP. To start Mr. A's LBP, the PJ worker accesses Mr. A's PJCase Person screen and selects LBP START to make entries to start Mr. A's LBP.

The PJ worker enters Mrs. A's social security number in the LBP Start Key Entry screen so that the system counts any previous LBPs chosen by Mr. or Mrs. A when deciding if the LBP will be a first or subsequent LBP. The LBP is started effective November 1 when the PJ worker confirms the entry.

To start Mrs. A's LBP, the PJ worker accesses her PJCase Person screen and selects LBP start. The PJ worker enters Mr. A's social security number in the LBP Start Key Entry screen.

The system will accept the PJ worker's entry so long as Mrs. A's choice date is before November 1, even if the start LBP entry is made after November 1.

When the system processes a start entry for a normal LBP on a case with a child or minor parent who has an active individual or partial LBP, the system includes the child or minor parent in the normal LBP.

However, the system will display the people in the partial or individual LBP with stop reason code "I" and the current date for a stop date. This also occurs when the partial or individual LBP is started first, and then the normal LBP is started.

PJ makes entries to start an LBP as soon as staff realizes the person has chosen an LBP and any needed review process confirms the LBP choice.

This is even more important when more than one person in the home has chosen an LBP and a *Notice of Decision* is needed for both LBPs, as a *Notice of Decision* is needed for both LBPs when an individual or partial LBP is started on a case with an active normal LBP.

The system will not accept individual or partial start entries made on a person who is active on a normal LBP chosen by another person in the home when the system cannot issue a *Notice of Decision* before the date benefits would have been issued. This means that the system will not accept such an entry when made on a day that is before the Start Date of the existing LBP.

The limitation for entry in this situation fluctuates each month due to weekends and holidays. The system knows when a *Notice of Decision* cannot be sent before the date that benefits would have been issued. So, in some months, the system will not accept an entry to start such an LBP even when the entry is made before the LBP Start Date.

When the system cannot accept your entry, the system will display the following message: "Invalid entry. This person is no longer on FIP due to another person's LBP." In this situation, you will not be able to start the individual or partial LBP.

NOTE: When starting an individual or partial LBP on a case with an existing active partial LBP, and the person who chose the new individual or partial LBP is included on the existing partial LBP, contact PJ QA for assistance.

## **Child Care Invoice Return Screen**

The Child Care Invoice Return screen is obsolete and the screen is not to be used.

## **Calendar Functions**

Calendar is the tool in PJCase designed to aid PJ and IM staff with scheduling appointments for clients being referred to PJ.

PJ staff allocate on the calendar the time slots they have available for appointments. The IM worker views available appointment times for each office and schedules clients for an appointment to meet with PJ to complete orientation and to write and sign an FIA.

## **Accessing Calendar**

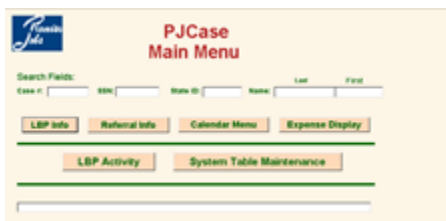

The PJCase Main Menu contains a button called CALENDAR MENU. Click on the button to proceed to the PJCase Calendar Menu screen.

## **PJCase Calendar Menu**

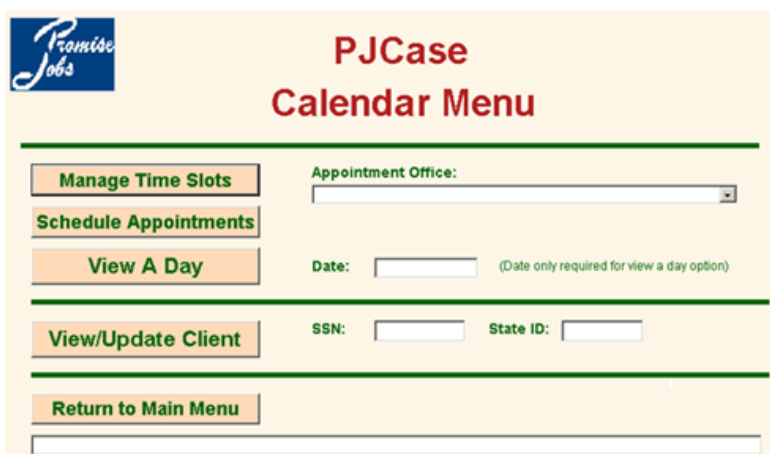

The PJCase Calendar Menu screen contains the following options for the worker to choose from:

- **Manage Time Slots:** Used by PJ staff only. PJ staff indicate on Calendar the time slots they have available to see clients for the completion of orientation and the writing and signing of an FIA. They can also use this option to delete open time slots previously entered.
- **Schedule Appointments:** Used by both PJ and IM staff to schedule FIA appointments with PJ.
- **View A Day:** Available to both PJ and IM staff to view all the scheduled FIA appointments on a specific day for any particular office.
- **View/Update Client:** Both PJ and IM staff use this option to view information regarding a specific client’s appointment time, date, location, and demographic information. This option also allows staff to delete an existing scheduled appointment.
- **Return to Main Menu:** Used to return to the PJCase Main Menu screen.

**Manage Time Slots Option**

PJ workers use this function to indicate to the IM staff what time slots they have available for appointments. IM staff are not authorized to use this function. Designated PJ workers can add or delete time slots using this feature.

NOTE: Calendar keeps track of all the available time slots and appointments for each office. It does not track the available appointments by each worker.

To access the Calendar Manage Time Slots screen, follow these steps:

Step	Action
1	 <p>On the PJCase Calendar Menu screen, use the dropdown box with the heading “Appointment Office:” to select your office.</p>
2	Click on the MANAGE TIME SLOTS button located on the Calendar Menu.

**Promise Jobs** **Calendar Manage Time Slots**

Office Name:

---

Date From:  Date To:

Time From:  AM  Time To:  AM

Number of Appointments to Add or Delete:

Monday	Tuesday	Wednesday	Thursday	Friday
<input type="text"/>	<input type="text"/>	<input type="text"/>	<input type="text"/>	<input type="text"/>

---

Screen field descriptions:

- **OFFICE NAME:** Displays the office chosen when accessing the Calendar Manage Time Slots screen. This is a “view only” field. If the field does not display the name of the office whose time slots you want to manage, click on the CANCEL button and re-enter the screen choosing the correct “Office Name” in the dropdown box on the PJCase Calendar Menu screen.
- **DATE FROM:** Enter the first date that you wish to add or delete time slots. The date must be in MM-DD-CCYY format.
- **DATE TO:** Enter the last date that you wish to add or delete time slots. The date must be in MM-DD-CCYY format. This date cannot be more than six months later than the date entered in the field titled DATE FROM.
- **TIME FROM:** Enter the beginning time of the time slot you wish to add or delete. Use the dropdown box to select AM or PM. It is possible to enter a time down to the minute but it is recommended that you enter time ending in “0” or “5.” Example: 1:00, 1:10, 1:15, etc.
- **TIME TO:** Enter the ending time of the time slot you wish to add or delete. Use the dropdown box to select AM or PM. It is possible to enter a time down to the minute but it is recommended that you enter time ending in “0” or “5.” Example: 1:00, 1:10, 1:15, etc.
- **NUMBER OF APPOINTMENTS TO ADD OR DELETE:** This field displays contains five subfields for each workday of the week. These fields are used to enter the number of appointments being added or deleted for the time slot for that day. See [Adding Time Slots](#) for more information.

### **Adding Time Slots**

PJ local offices make time slots available for appointments by designated staff determining the time slots available for the entire office. Each PJ worker has access to add time slots for themselves if a situation arises that would require them to add a time slot.

**Important:** Calendar allows only nine time slots per day, per office, but there can be many appointments within each of those time slots. PJ local offices establish guidelines for those time slots.

Office X has five PJ workers that see clients for appointments. If the first available appointments are scheduled as follows:

- Worker #1 = 8:00 AM – 9:00 AM.
- Worker #2 = 8:00 AM – 8:45 AM.
- Worker #3 = 8:00 AM – 8:30 AM.
- Worker #4 = 8:05 AM – 9:00 AM.
- Worker #5 = 8:05 AM – 8:45 AM.

Calendar counts each appointment as an available slot since none of these slots match exactly. Therefore, this office has used up five of their nine available appointments slots with the “first round” of appointments for the day. If all the workers had chosen the same start and end times, Calendar would have counted it as only one time slot.

The following steps show how to add time slots once you are at the Calendar Manage Time Slots screen.

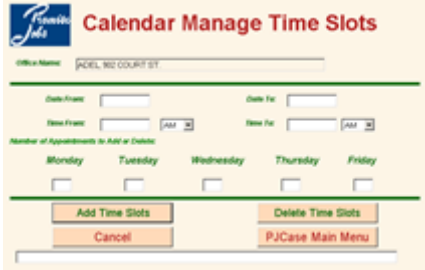
Step	Action
1	 <p>Verify that the OFFICE NAME: field is correct.</p>
2	<p>In the DATE FROM: and DATE TO: fields, enter the span of dates that you intend to add time slots for. The Calendar system will automatically exclude state holidays and weekends.</p> <ul style="list-style-type: none"> <li>▪ The DATE FROM: can be any date beginning with the current date.</li> <li>▪ The DATE TO: can be no more than six months past the date entered in the DATE FROM: field.</li> </ul>

Step	Action
3	<p>Use the TIME FROM: and TIME TO: fields to enter the beginning and ending time of the appointment slot. This should be the time of each appointment slot, not the <b>total</b> time that you will be seeing appointments.</p> <p>For example, if you decide to see clients between 8:00 AM and noon and your appointment times last for one hour, your appointment times will be from 8:00 AM – 9:00 AM, 9:00 AM – 10:00 AM, and so on. Do <b>not</b> indicate in the TIME FROM: and TIME TO: fields that your available time slot is 8:00 AM – 12:00 PM.</p>
4	<ul style="list-style-type: none"> <li>▪ For each day of the week, enter the number of appointments that you will be able to see for the period indicated above. If you are adding a slot for yourself, enter “1” for each day of the week that you are available for an interview during the period you indicated. If there is a day of the week that you do not want to show as available, leave it blank. If you enter a “1” in a day of the week, the “1” will be added to the total available slots for your office on that day and at that time.</li> </ul> <div style="border: 1px solid black; padding: 10px; margin-top: 10px;"> <p>Worker B is adding an available time slot for himself from 10:00 AM to 10:30 AM for Monday, 10-04-20XX. He enters a “1” in the MONDAY field.</p> <p>Workers A and C have already indicated on the system that they have an available time slot on that Monday for the same time. The Calendar system will add Worker B’s entry of “1” to his co-workers’ entries and count a total of three available appointments for that time slot for the office.</p> <p>When an IM worker seeks to schedule an appointment for that Monday, the system will show three available appointments for the time slot 10:00 AM – 10:30 AM, unless one or more has already been filled. (See <a href="#">Schedule Appointments Option</a> for more details.)</p> <p>NOTE: If Worker B indicates his time slot is 10:00 AM – 11:00 AM, that slot will show as separate from his co-workers’ available slots, because the time does not match exactly.</p> </div>

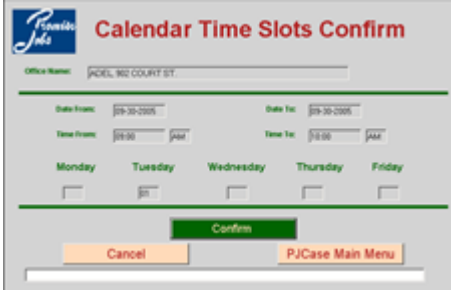
Step	Action
	<ul style="list-style-type: none"> <li>▪ If you are adding time slots for the entire office or a unit within the office, you must indicate in each day of the week field how many appointment slots are available for the entire office or unit for each specific time slot.                             <div style="border: 1px solid black; padding: 10px; margin: 10px 0;"> <ol style="list-style-type: none"> <li>1. Small County has six PJ workers who will see clients. However, one of those workers is out of the office on Fridays. The workers decide that they will begin seeing people at 9:00 every day and each appointment lasts one hour.  The person setting up the appointments enters the span of dates she wants to cover and then the first available appointment time of 9:00 AM - 10:00 AM. She then enters “6” in each of the work day fields except Friday, where she enters “5.” She does the same thing for each time slot (10:00 AM – 11:00 AM, 11:00 AM – 12:00 PM, etc.).</li> <li>2. Big County has 20 PJ workers who will see clients. The office has two lead workers who oversee ten PJ workers each and has decided that the lead workers will establish the available time slots for their own units. Both lead workers decide the first available time slot will be 9:00 AM – 10:00 AM Monday through Friday.  If all the workers are available to see clients at this time, each lead worker enters “10” in each day of the week field. When a worker seeks to schedule an appointment for a client, that period shows that there are 20 available slots.</li> </ol> </div> </li> </ul>
5	Click on ADD TIME SLOTS to display the Calendar Time Slots Confirm screen.
6	 <p>Verify that the information on the screen is correct.</p>



Step	Action
	<ul style="list-style-type: none"><li>▪ If the information is correct, click on the CONFIRM button. You will either receive a message stating that your entries updated successfully or that there is something wrong with your entries that will not allow the entries to update. If there is a problem with your entries, make the appropriate changes and retry.</li><li>▪ If you see a problem with your entries, select:<ul style="list-style-type: none"><li>• The browser BACK button to return to the Calendar Manage Time Slots screen, or</li><li>• CANCEL to return to the PJCase Calendar MENU screen, or</li><li>• PJCASE MAIN MENU to return to the PJCase Main Menu screen.</li></ul></li></ul>

### **Other Notes for Adding Time Slots**

Here are some additional notes that may be helpful when adding time slots.

- The system will not allow you to add a time slot on a state holiday or a weekend. You will receive an error message when you attempt to confirm your entries.
- If the date you enter does not correspond with the day of the week you enter, the system will not allow your entry to update. For example, if while adding a time slot for a Friday, you accidentally enter a “1” in the THURSDAY field instead of the FRIDAY field, you will receive an error message when you attempt to confirm your entries.

### **Deleting Time Slots**

It may sometimes be necessary to delete or reduce the number of appointments available within a time slot. For example, if a worker will be going on vacation for a week, you should delete one appointment in each time slot that the worker would normally be available to see a client.

NOTE: Deleting time slots or appointments within time slots does not delete any existing appointments scheduled for that period. To view existing scheduled appointments, see [View a Day Option](#).

You must know the exact begin and end times for each appointment slot you want to delete. If you are not sure, use the Schedule Appointments option to view the PJCase Calendar Day screen for the exact begin and end times for each appointment for a specific day for your office. See [Schedule Appointments Option](#) section.

Follow the steps below to delete time slots or available appointments within a time slot.

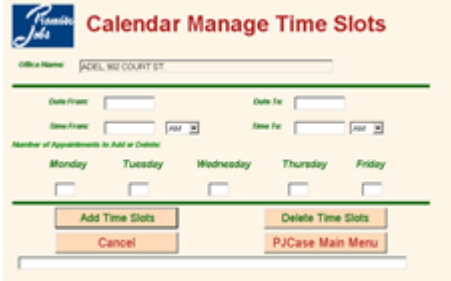
Step	Action
1	 <p>On the PJCase Calendar Menu screen, use the dropdown box with the headings “Appointment Office:” to select your office.</p>
2	 <p>Click on MANAGE TIME SLOTS located on the PJCase Calendar Menu.</p> <p>Verify that the OFFICE NAME: field is correct.</p>
3	<p>Make entries in the DATE FROM: and DATE TO: fields to indicate the span of dates for which you intend to delete time slots. (If you are deleting a slot for one day, enter the same date in both fields.)</p>
4	<p>Use the TIME FROM: and TIME TO: fields to enter the exact beginning and ending time of the appointment slot you want to delete.</p>

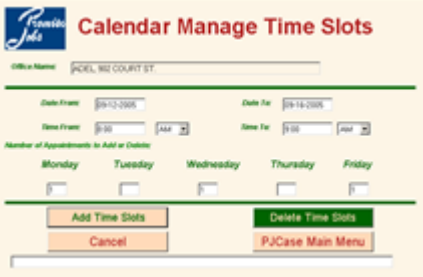
Step	Action
5	<p>In the days of the week fields, enter the number of appointment slots you want to delete for the time slot and dates you indicated in the DATE and TIME fields.</p> <p>NOTE: If you are deleting the entire time slot and you are not sure how many appointments are available within the time slot, you can enter a number that you know is greater than the number of appointments available. See Example 2.</p> <div style="border: 1px solid black; padding: 10px; margin: 10px 0;"> <p>1. Worker B has previously indicated on Calendar that he is available to see clients every Monday, Wednesday, and Friday from 8:00 AM – 9:00 AM. He will be on vacation from Monday, September 12 through Friday, September 19. He needs to delete his available appointment slots for that week.</p> <p>On the CALENDAR MANAGE TIME SLOTS screen, Worker B enters 09-12-20XX in DATE FROM, 09-16-20XX in DATE TO, 8:00 AM in TIME FROM, and 9:00 AM in TIME TO. In the days of the week fields, he enters a “1” under MONDAY, WEDNESDAY, and FRIDAY.</p>  </div> <p>2. The Des Moines Service Area PJ office has six available appointments within the 9:30 AM – 10:30 AM time slot for Tuesday, September 13. They have just been informed of a meeting that all workers must attend during that period on that day. They must delete the entire time slot so that no appointments are scheduled.</p> <p>The worker designated to delete the time slot enters 09-13-20XX in both the DATE FROM: and DATE TO: fields, 9:30 AM in TIME FROM, 10:30 AM in TIME TO, and “6” under TUESDAY. (The worker could enter any number from “6” to “99” and the system would delete the entire time slot.)</p>

Step	Action
	<div data-bbox="542 359 971 646" data-label="Image"> </div> <p data-bbox="542 680 1365 804">NOTE: Since the office is deleting all the available appointments within the 9:30 AM – 10:30 AM time slot, the time slot will no longer appear as an option on the PJCase Calendar Day screen when someone tries to schedule an interview for that day.</p>
6	<p data-bbox="451 905 1344 968">Click on DELETE TIME SLOTS. This will display the Calendar Time Slots Confirm screen.</p> <div data-bbox="451 989 891 1272" data-label="Image"> </div> <p data-bbox="451 1289 529 1318">Select:</p> <ul data-bbox="451 1346 1170 1442" style="list-style-type: none"> <li>▪ CONFIRM to continue deleting the appointment slots, or</li> <li>▪ CANCEL to return to the PJCase Calendar Menu screen, or</li> <li>▪ PJCASE MAIN MENU to return to the PJCase Main Menu.</li> </ul>

### **Schedule Appointments Option**

IM and PJ workers use the Schedule Appointments feature to schedule an FIA appointment with PJ for a FIP applicant.

PJ staff also use this feature to reschedule an appointment that an IM worker had previously scheduled for a client. (The original appointment must be deleted before rescheduling a new one. Past appointments cannot be deleted. See the [View/Update Client Option](#) section.)

### **PJCase Calendar Available Days Screen**

To access the PJCase Calendar Available Days screen, follow these steps:

Step	Action
1	 <p>On the PJCase Calendar Menu screen, use the dropdown box with the headings <b>APPOINTMENT OFFICE:</b> to select the office where you want to schedule the appointment.</p>
2	<p>Click on Schedule Appointments. The PJCase Calendar Available Days screen displays the OFFICE NAME for the location in which you are scheduling an appointment.</p> <p>The first ten workdays beginning with the current day's date are displayed on buttons. Days with available appointments are in color and clickable; if the date has a white background and is not clickable, there are no available appointment slots for that date. See screenshot below for reference.</p>
3	<p>Click on the date when you want to schedule an appointment. This displays the PJCase Calendar Day screen for the date chosen.</p>

**Promise Jobs**

## PJCase Calendar Available Days

Office Name: MASON CITY, 600 S. PIERCE AVE, STE 2

WED 09-07-2005 THU 09-08-2005 FRI 09-09-2005 MON 09-12-2005 TUE 09-13-2005

WED 09-14-2005 THU 09-15-2005 FRI 09-16-2005 MON 09-19-2005 TUE 09-20-2005

Next 10 Working Days Previous 10 Working Days

Return to Calendar Menu PJCase Main Menu

The following action buttons are located at the bottom of the page:

- **NEXT 10 WORKING DAYS:** Click to view the next ten working days. Continue clicking on the button to move through the calendar. (Offer the first available appointment. This should be within the first ten days of the referral.)
- **PREVIOUS 10 WORKING DAYS:** Click to scroll back to the current date.
- **RETURN TO CALENDAR MENU:** Click to display the PJCase Calendar Menu.
- **PJCASE MAIN MENU:** Click on the button to return to the PJCase Main Menu screen.

### PJCase Calendar Day Screen

**Promise Jobs**

## PJCase Calendar Day Screen

Office Name: DAVENPORT, 902 W. KIMBERLY ROAD, SUITE #51

Tuesday September 13, 2005

09:00 AM TO 10:00 AM (02) 10:00 AM TO 11:00 AM (01) 11:00 AM TO 12:00 PM (01)

01:00 PM TO 02:00 PM (01) 02:00 PM TO 03:00 PM (02) 03:00 PM TO 04:00 PM (02)

Return to Available Days PJCase Main Menu

PJCase Calendar Day screen displays all the available time slots for that office for that day. There can be up to nine time slots displayed for each day.

Each time slot is displayed on a button. The number of appointments available within a time slot is displayed in parentheses and updates in real time.

Select either:

- RETURN TO AVAILABLE DAYS to return to the PJCase Calendar Available Days screen, or
- PJCASE MAIN MENU to return to the PJCase Main Menu screen.

### **Scheduling Appointments When More Than Person Is Referred**

In some instances, more than one household member needs to be scheduled for a PJ appointment. Calendar tracks scheduled appointments by client state identification numbers and social security numbers rather than the case number. Therefore, if you schedule interviews for each household member being referred, you would be using more than one time slot. Unless the household is unable to attend the same appointment for some reason, follow these steps to schedule multiple household members for the same time slot:



- When one of the people being referred is the case name, use that person's state identification or social security number when scheduling the appointment.
- When scheduling an appointment for more than one household member, indicate the names of the other people being referred in the COMMENTS field of the PJCase Calendar Appointment screen.

NOTE: Try to fit the names in the COMMENTS 1: field. The information entered in this field will be displayed on the PJCase Calendar View a Day screen. Currently, information entered in the COMMENT 2: field does not display on the PJCase Calendar View a Day screen.

### **Steps to Schedule an Appointment**

You must first delete any existing scheduled appointments for the client before scheduling a new one. Past appointments cannot be deleted. See [View/Update Client Option](#) section for instructions to delete a scheduled appointment.

When a client does not have an existing appointment, follow these steps to schedule an FIA appointment for the client.

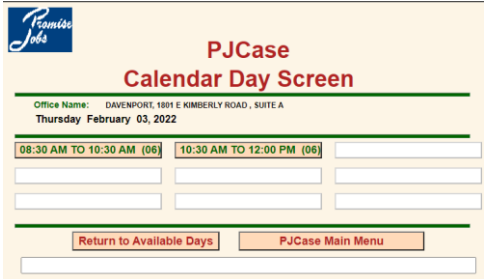
Step	Action
1	 <p>From the PJCase Calendar Menu screen, use the dropdown box to select the Appointment Office where you wish to schedule an appointment. Click on the SCHEDULE APPOINTMENTS button to display the PJCase Calendar Available Days screen.</p>
2	 <p>Choose the date you want to schedule the interview. (Dates that are shown with a white background do not have any open time slots.)</p> <p>Click on NEXT 10 WORKING DAYS to scroll forward to the next ten workdays.</p> <p>Click on the date to display the PJCase Calendar Day Screen.</p>
3	 <p>Choose the time slot for the appointment you want to schedule by clicking on the appropriate button. This will display the PJCase Calendar Schedule Key Entry screen.</p> <p>If you want to view the available time slot for a different day, click on RETURN TO AVAILABLE DAYS to return to the PJCase Calendar Available Days screen and repeat Step 2.</p>

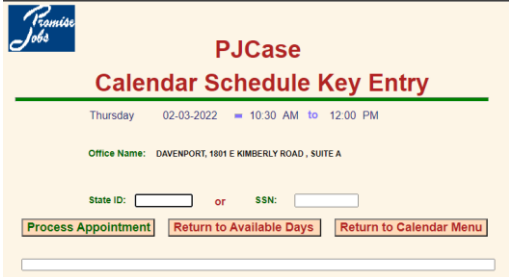
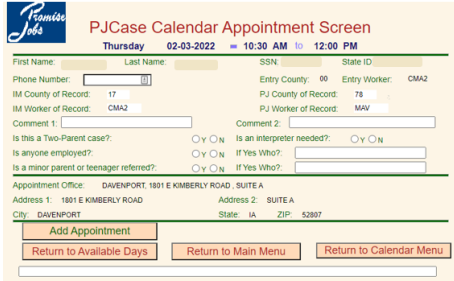

Step	Action
4	 <p>This screen displays the day, date, time, and location of the appointment you are scheduling. If the information is correct, enter the client's state identification number or social security number and click on PROCESS APPOINTMENT to display the PJCase Calendar Appointment screen.</p> <p>If the information on the screen is not correct, select either:</p> <ul style="list-style-type: none"> <li>▪ RETURN TO AVAILABLE DAYS SCREEN to return to the PJCase Calendar Available Days screen, OR</li> <li>▪ RETURN TO CALENDAR MENU to return to the PJCase Calendar Menu screen.</li> </ul>
5	 <p>Verify that all the information on the screen is correct. See <a href="#">View/Update Client Option</a> section for field descriptions.</p> <p>IM staff must enter the client's current phone number in the Phone Number field. If the client does not have a current phone number, IM staff need to enter zeros in the field.</p> <p>Use the Comment 1: and Comment 2: sections to add any additional information that may be useful to the PJ worker.</p> <p>Select either "Y" for yes or "N" for no for these four required questions:</p> <ul style="list-style-type: none"> <li>▪ Is this a two-parent case?</li> <li>▪ Is an interpreter needed?</li> <li>▪ Is anyone employed?</li> <li>▪ Is a minor parent or teenager being referred?</li> </ul>

If either the “Is anyone employed?” or “Is a minor parent or teenager being referred?” question is answered with “Y,” complete the associated “If Yes, Who?” box with the person’s name.

If “Is an interpreter needed?” is answered with a “Y”, include the language used by the client in one of the comment sections.

If the information on the screen is correct, click on **ADD APPOINTMENT**. If the appointment was added successfully, you will receive a message. If there is a problem with your entry, you will receive an error message.

The other buttons on the screen are:

- **RETURN TO AVAILABLE DAYS**. This will return you to the PJCase Available Days screen.
- **RETURN TO MAIN MENU**. This will return you to the PJCase Main Menu screen.
- **RETURN TO CALENDAR MENU**. This will return you to the PJCase Calendar Menu screen.

### **Other Notes When Scheduling an Appointment**

When scheduling an appointment for a client, here are some other things to remember:

- Remember to complete form 470-3897, *FIA Appointment*, after scheduling the appointment on Calendar.
- When a PJ worker schedules an appointment for a client, an email is sent to the client’s IM worker to notify the worker of the scheduled appointment.

### **View a Day Option**

Both IM and PJ staff use the “view a day” option to view all the appointments scheduled for a specific office on a particular day. As the name implies this option is a view-only feature.

To view the appointments for a day, follow these steps:

Step	Action
1	 <p>On the PJCase Calendar Menu screen, use the dropdown box with the heading <b>APPOINTMENT OFFICE:</b> to select the office where you want to view the scheduled appointments.</p>
2	Enter the date you wish to view in the DATE: field in MM-DD-CCYY format.
3	Click on VIEW A DAY to display the PJCase View A Day screen.

**PJCase Calendar View A Day**

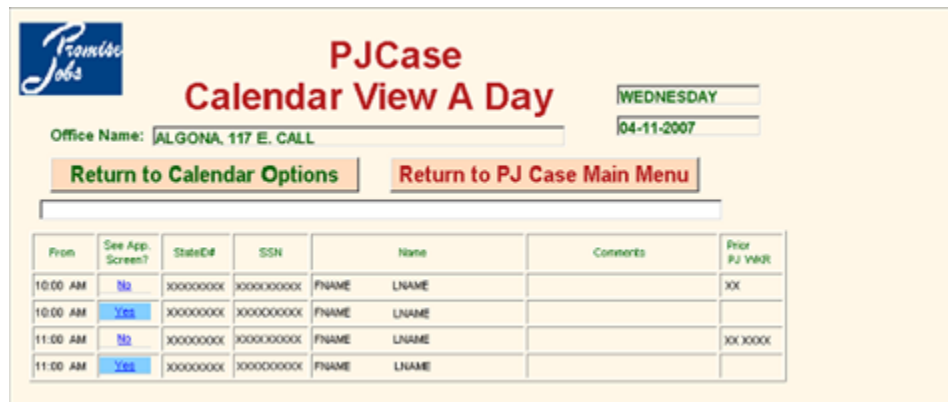

The screen displays the day of the week, the date, and office for the scheduled appointments.

The other field descriptions are:

- **FROM:** This is the beginning time of the scheduled appointment.
- **SEE APP. SCREEN?:** A “Yes” in this column indicates one of the questions on the PJCase Calendar Appointment screen was answered Yes. Click YES to view the appointment.
- **STATE ID#:** This is the client’s state identification number.
- **SSN:** This is the client’s social security number.
- **NAME:** This is the client’s first and last name.

- **COMMENTS:** This field displays any comments that have been entered in the COMMENT 1: field on the client’s PJCase Calendar Appointment screen. See [View/Update Client Option](#).
- **PRIOR PJ WKR:** This field displays the county number from the PJ COUNTY OF RECORD: field and the PJ WORKER OF RECORD: field, if entered, as displayed on the PJCase Calendar Appointment screen. See [View/Update Client Option](#).
- **RETURN TO CALENDAR OPTIONS** returns you to the PJCase Calendar Option Menu screen.
- **RETURN TO PJCASE MAIN MENU** returns you to that screen.

### View/Update Client Option

This feature allows PJ and IM workers to search the Calendar database for a client who has a scheduled PROMISE JOBS appointment. Once the person’s PJCase Calendar Appointment screen is located, the worker can:

- Delete the existing appointment,
- Make a new appointment (after deleting the existing one), and
- Add, change, or delete comments in the COMMENT 1: and COMMENT 2: fields.

To access a person’s PJCase Calendar Appointment screen, follow these steps.

Step	Action
1	 <p>On the PJCase Calendar Menu screen, enter either the client’s social security number or state identification number in the appropriate field.</p>
2	Click on VIEW/UPDATE CLIENT to display the PJCase Calendar Appointment screen.

## PJCase Calendar Appointment Screen

**PJCase Calendar Appointment Screen**  
Wednesday 01-19-2022 09:00 AM to 11:30 AM

First Name: Last Name: SSN: State ID:

Phone Number: (515) 555-1111 Entry County: 17 Entry Worker: CMA2  
IM County of Record: 17 PJ County of Record: 78  
IM Worker of Record: CMA2 PJ Worker of Record: 7835

Comment 1: Comment 2:

Is this a Two-Parent case?  Y  N Is an interpreter needed?  Y  N  
Is anyone employed?  Y  N If Yes Who?:  
Is a minor parent or teenager referred?  Y  N If Yes Who?:

Appointment Office: COUNCIL BLUFFS, IOWAWORKS, 300 W BROADWAY #13  
Address 1: IOWAWORKS Address 2: 300 W BROADWAY #13  
City: COUNCIL BLUFFS State: IA ZIP: 51503

Delete Appointment Update Comment  
Return to Available Days Return to Main Menu Return to Calendar Menu

The PJCase Calendar Appointment screen displays the date and time of the appointment, and information regarding the client, the IM worker, and the PJ office where the appointment is scheduled.

Screen field descriptions:

- **FIRST NAME:** The client's first name.
- **LAST NAME:** The client's last name.
- **SSN:** The client's social security number.
- **STATE ID:** The client's state identification number.
- **PHONE NUMBER:** The client's phone number.
- **ENTRY COUNTY:** The county number of the IM or PJ worker who scheduled the appointment.
- **ENTRY WORKER:** The worker number of the IM or PJ worker who scheduled the appointment.
- **IM COUNTY OF RECORD:** The county number where the client's FIP case is located.
- **PJ COUNTY OF RECORD:** The county number of the county where the PROMISE JOBS worker is located.
- **IM WORKER OF RECORD:** The worker number of the IM worker assigned to the client's FIP case.
- **PJ WORKER OF RECORD:** The worker number of the assigned PJ worker.
- **COMMENT 1:** This field allows both IM and PJ workers to enter up to 26 characters of additional information. This information is also displayed in the COMMENTS field of the PJCase Calendar View A Day screen where this appointment is listed.
- **COMMENT 2:** This field allows both IM and PJ workers to enter up to 35 characters of additional information that does not fit into the COMMENT 1: field. This field does NOT show on the PJCase Calendar View A Day screen where the appointment is listed.

- **IS THIS A TWO-PARENT CASE?:** If this is a two-parent FIP case, select the “Y” button; otherwise select the “N” button. A selection is required in order to add an appointment.
- **IS AN INTERPRETER NEEDED?:** If an interpreter is needed, select the “Y” button, otherwise select the “N” button. A selection is required in order to add an appointment. Be sure to include the language needed in one of the two comment fields.
- **IS ANYONE EMPLOYED?:** If anyone needing an appointment is employed, select the “Y” button; otherwise select the “N” button. A selection is required in order to add an appointment.
- **IF YES, WHO?:** If the “Is anyone employed?” question was answered “Y,” the name of the employed person must be entered in this field.
- **IS A MINOR PARENT OR TEENAGER REFERRED?:** If a minor parent or teenager is referred, select the “Y” button; otherwise select the “N” button. A selection is required in order to add an appointment.
- **IF YES, WHO?:** If the “Is a minor parent or teenager referred?” question was answered “Y,” then entry must be made in this field. Enter the name of the minor parent or teenager referred.
- **APPOINTMENT OFFICE:** The location of the PJ office where the appointment is scheduled.
- **ADDRESS 1:** The primary street address of the PJ office where the interview is scheduled.
- **ADDRESS 2:** The secondary street address of the PJ office where the interview is scheduled.
- **CITY:** The city of the PJ office where the interview is scheduled.
- **STATE:** The state where the PJ office is located.
- **ZIP:** The zip code of the PJ office where the interview is scheduled.

### **Delete an Appointment**

To cancel a client’s appointment, click on DELETE APPOINTMENT while on the client’s PJCase Calendar Appointment screen.

### **Update the Comment Fields**

If you have information that needs to be added, deleted, or changed in the COMMENT 1: or COMMENT 2: field, make your entry or changes in the appropriate field and click on the UPDATE COMMENT button.

### **Reschedule an Appointment**

If it is necessary to reschedule a current or future appointment, you must first delete the existing appointment and then add a new one. See the [Delete an Appointment](#) and [Steps to Schedule an Appointment](#) sections.